

---

---

# *Caplio*<sup>\*</sup> *RR30*

**RICOH**

## **Operation Manual**

---

---

# Using These Manuals

The two manuals attached are for your Caplio RR30.

## Please read this first:

Quick Start guide (printed manual)

This booklet is designed to help you enjoy your Caplio RR30 right away by providing quick explanations: "Getting Ready to Shoot", "Shooting Images", "Viewing Images", and "Connecting to Your PC."

Before using your camera, first read this manual.



## Please read as needed:

Operation Manual (this manual).

This explains how to use all the functions of your Caplio RR30.

To get the most out of your Caplio RR30, please read it through once. Also, refer to it whenever necessary.

# Meaning of Symbols

The following symbols are used in this guide:



### Important

This indicates important information and restrictions.



### Memo

This indicates supplementary explanations and useful tips on camera operations.



### Glossary

This indicates an explanation of a technical term.



### Reference

This indicates page(s) relevant to a particular function.

"p.xx" is used to refer you to pages in this manual.

# Table of Contents

Using These Manuals .....	2	About Image Size .....	52
Meaning of Symbols .....	2	Changing Picture Quality	
<b>Chapter 1 Using Your Camera</b>		Mode/Image Size of a Still Image .....	53
<b>Section 1 Getting Started</b>		Changing the Image Size of a Movie .....	54
Checking Everything is Packed .....	6	Manual Focus Shooting (FOCUS).....	55
Names of Parts .....	7	Manual Focus Shooting .....	55
How to Use the Mode Dial .....	8	Shooting at a Fixed Shooting Distance .....	56
Inserting the Batteries .....	9	Changing the Light Metering (PHOTOMETRY).....	57
Using the AC Adaptor .....	10	Making Sensitivity Settings (ISO SETTING).....	59
Turning the Power On/Off .....	11	Changing the Edge Quality of Still Images	
Setting the Date and Time .....	12	(SHARPNESS).....	60
Inserting the SD Memory Card .....	13	Shooting Consecutively with Different Exposures	
How to Use the LCD Monitor .....	14	(AUTO BRACKET).....	61
Screen Examples when Shooting Pictures.....	14	Setting the Exposure Time	
The Screen During Playback.....	17	(TIME EXPOSURE) .....	63
Switching the Screen Display .....	18	Shooting Pictures Automatically at Set Intervals	
Button Functions .....	19	(INTERVAL) .....	64
Screens .....	20	Inserting the Date into a Still Image	
The Basics of the		(DATE IMPRINT).....	66
Shooting Menu/Playback Menu .....	24	Returning the Shooting Menu Settings to their Defaults	
The Basics of the Setup Screen .....	25	(RESTORE DEFAULTS).....	67
<b>Section 2 Basic Shooting</b>		Displaying the Grid Guide on the LCD Monitor .....	68
How to Hold the Camera.....	27	Changing Shading for Shooting Text	
How to Focus .....	28	(DENSITY) .....	69
Shooting Still Images .....	30	<b>Section 4 Viewing Still Images and Movies</b>	
Check the Focus and Shoot (Half-press)) .....	30	Viewing the Photo You Just Took.....	71
Capture the Moment Shooting (Full-Press).....	31	Displaying an Enlarged View of the Still Image Dis-	
When the subject is not		played .....	72
centered on your composition (Focus Lock).....	32	Deleting the Displayed Still Image or Movie.....	73
Shooting with Scenery-Matching .....	33	Viewing a Still Image or Movie .....	74
Combination of		Viewing Still Images	
Scene Mode and Function.....	35	Recorded on an SD Memory Card.....	74
Shooting with Multi-Shot .....	36	Viewing Still Images Recorded	
Making Multi-Shot Settings (CONT. MODE) .....	37	on Internal Memory .....	75
Shooting with Multi-Shot.....	38	Viewing Movies .....	76
Shooting with S Multi-Shot .....	38	Viewing at a Glance.....	77
Shooting with M Multi-Shot.....	38	Enlarged Viewing.....	78
Shooting Movies .....	39	Showing Photos in Order Automatically	
Shooting with the Zoom .....	40	(SLIDE SHOW) .....	79
Shooting with the Digital Zoom .....	41	Viewing on a Television.....	80
Shooting Close-ups (Macro Photo).....	42	<b>Section 5 Deleting Still Images and Movies</b>	
<b>Section 3 Using Special Features for Improved Photography</b>		Deleting Unwanted Still Images or Movies .....	82
Using the Flash .....	44	Deleting one Still Image .....	82
Using the Self-Timer .....	46	Deleting All Frames at Once .....	83
Changing the Exposure (EXPOSURE COMP.) .....	47	Deleting Multiple Frames at Once .....	84
Using Natural and Artificial Lighting		Write-protecting Your Images (PROTECT) .....	85
(WHITE BALANCE).....	49	Protecting the Displayed Still Image .....	85
Choosing Picture Quality Mode/Image Size		Protecting All Still Images .....	87
(PIC QUALITY/SIZE).....	49	Protecting multiple	
About Picture Quality Mode.....	52	Still Images or Movies at Once .....	88
		Copying the Contents of Internal Memory to a	
		Memory Card (COPY TO CARD).....	89
		Using a Printing Service (PRINT) .....	90

Setting DPOF for the Still Image Displayed.....	90
Setting DPOF for All Still Images.....	91
Setting DPOF for Multiple Still Images .....	92
<b>Section 6 Changing Camera Settings</b>	
Getting the SD Memory Card Ready for Use	
(CARD FORMAT).....	94
Write-protecting your images.....	94
Formatting internal memory (IN FORMAT).....	95
Changing Power-Save Mode Settings	
(POWER SAVE).....	96
Changing Auto Power-Off Settings	
(AUTO POWER OFF) .....	97
Buzz at Recording (BEEP SOUND).....	98
Changing File Name Settings	
(SEQUENTIAL NO.).....	99
Changing Image Confirmation Time	
(LCD CONFIRM.) .....	100
Adjusting the Brightness of the LCD Monitor	
(LCD BRIGHTNESS).....	101
Changing the Display Language	
(LANGUAGE) .....	102
Changing the Playback Method for Viewing on TV	
(VIDEO OUT MODE).....	103

## Chapter 2 Enjoying Images on a Computer (Pictures/Movies)

<b>Section 1 Downloading Images to a Computer</b>	
Using the Software Provided .....	105
Software and OS Applicability Table .....	105
Necessary Environment for	
Using the Software Provided .....	106
Installing the Software.....	108
For Windows 98/98SE/Me/2000.....	109
Uninstalling the software	
(For Windows 98/98SE/Me/2000) .....	111
For Windows XP.....	112
Uninstalling the software	
(For Windows XP) .....	113
For Mac OS 8.6 to 9.2.2 .....	114
Uninstalling the software	
(For Mac OS 8.6 to 9.2.2).....	115
For Mac OS X 10.1.2 to 10.1.4.....	116
Uninstalling the software	
(For Mac OS X 10.1.2 to 10.1.4) .....	117
Connecting the Camera to a Computer .....	118
Downloading Pictures to Your Computer.....	119
For Windows 98/98SE/Me/2000.....	120
For Windows XP.....	121
For Mac OS 8.6 to 9.2.2 .....	123
For Mac OS X.....	124
The RICOH Gate L Window .....	125
(Windows 98/98SE/Me/2000).....	125
How to use RICOH Gate L.....	125
How to use Option settings.....	126
How to use the	

Background Illustration Settings .....	127
The RICOH Gate L Window	
(For Mac OS 8.6 to 9.2.2) .....	128
How to use [Optional Settings].....	129
For Downloading Images Directly to Your Computer	
from an SD Memory Card .....	130
Images in a PC Card.....	130
<b>Section 2 Displaying Thumbnail Images (How to Use DU-10)</b>	
Starting and Exiting DU-10 .....	132
DU-10 Window .....	132
Exiting DU-10 .....	132
Thumbnail Display Description .....	133
Switching the Ordering of Images .....	134
Changing the Display Size .....	135
To View a Slideshow.....	136
Using Auto Slideshow .....	137
How to use the Slideshow Dialog Box .....	137
Viewing Image Information .....	138
Using the [File] menu .....	138
Using the shortcut menu .....	138
Displaying the Viewer Screen.....	139
Viewer Screen.....	139

<b>Appendix</b>	
A. Specifications .....	141
B. Optional Accessories .....	143
C. SD Memory Card Recording Capacities .....	143
D. Using Your Camera Abroad.....	143
E. Care and Storage .....	144
F. Troubleshooting.....	145
G. Error Messages .....	151
H. About the Warranty and Servicing .....	152



# **Chapter 1 Using Your Camera**

## **Section 1 Getting Started**

---

This section explains how to get your camera ready, from taking it out of the package till preparing to shoot.

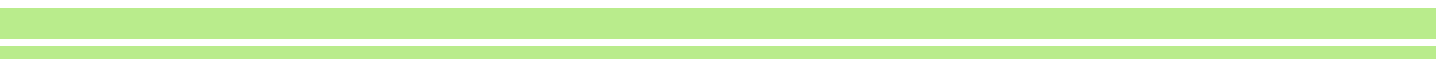

## Checking Everything is Packed

The following items should be included with the camera. Let's make sure everything was packed.

CaplioRR30

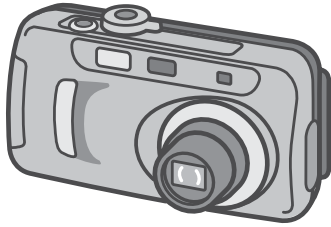

CD-ROM

- ✓ The software and the Operation manual are included.

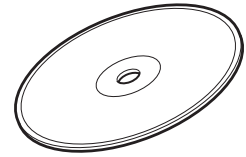

Video Cable

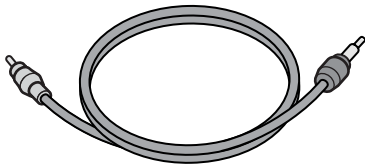

USB Cable

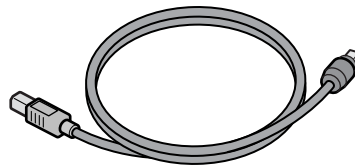

AA Alkaline Batteries (2)

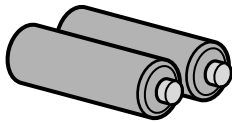

Handstrap

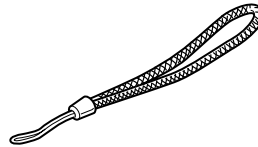

Quick Start Guide



Warranty Card

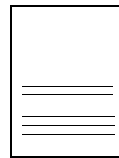

### Attaching the Handstrap

Thread the tip of the strap through the camera's strap peg and attach it as shown in the diagram.

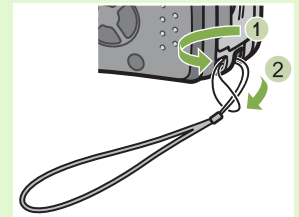

### Optional Accessories

AC Adaptor (AC-4a)

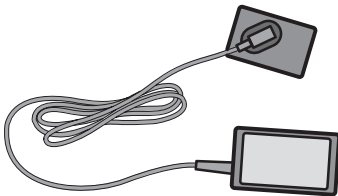

Rechargeable Battery (DB-43)

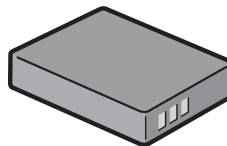

Battery Charger (BJ-2)

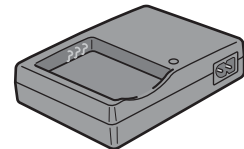

- Other products sold separately: PC Card Adaptor (FM-SD53), Rechargeable Battery (DB-40)



- In the unlikely event that something is missing or damaged, please contact the store where you purchased the camera.
- After checking the contents of the warranty card, please keep it in a safe place.

## Names of Parts

It is necessary to know these in order to understand the explanations in this manual. Check the following.

### ■ Camera Front View

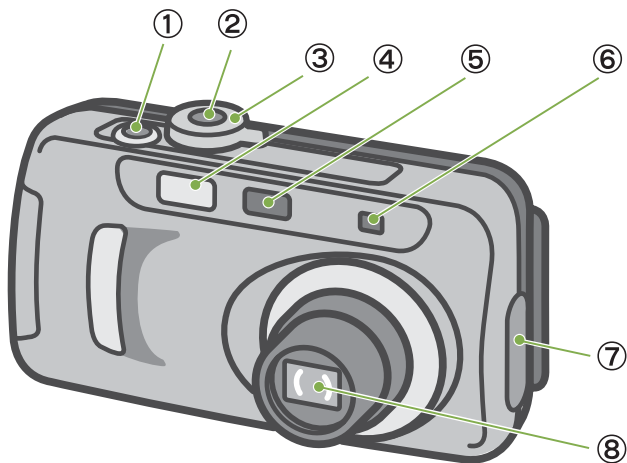

1. Shutter button
2. Power button
3. Mode Dial
4. Flash
5. AF Window
6. Viewfinder
7. Terminal Cover
8. Lens
9. USB Terminal
10. Video Out Terminal

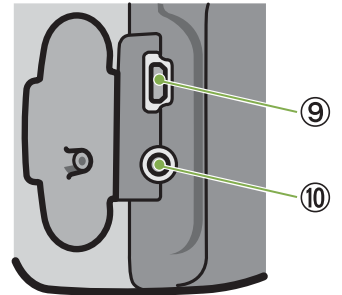

### Rear View

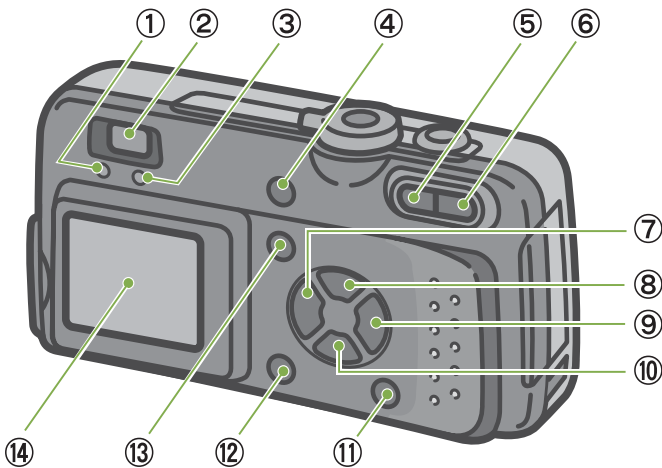

1. Auto Focus Lamp
2. Viewfinder
3. Flash Lamp
4. (Delete)/ (Self-timer) Button
5. (Wide-angle)/ (Thumbnail Display) Button
6. (Telephoto)/ (Enlarged View) Button
7. (Quick Review) Button
8. (Flash) Button
9. Button
10. (Macro) Button
11. **DISPLAY** Button
12. **OK** Button
13. **MENU** Button
14. LCD Monitor
15. Battery Cover
16. Memory Card Cover
17. Power (DC In) Cable Cover
18. Strap Attachment Peg
19. Tripod Mount (Bottom)

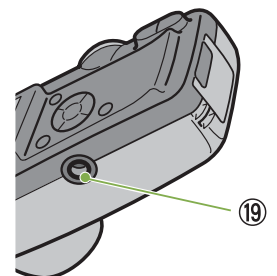
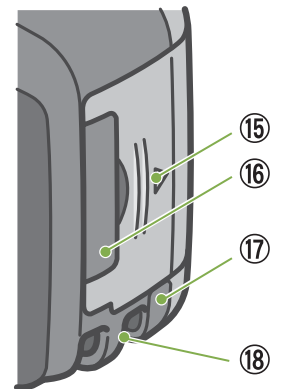

## How to Use the Mode Dial



The Mode Dial is on the top of the camera.

The Mode Dial is used to select the desired mode and operation for shooting and playback (still image viewing).

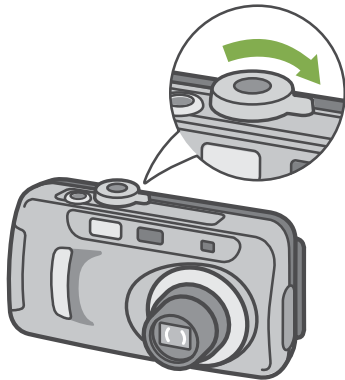
- 1 Turn the Mode Dial to the symbol of the mode you want to use.



### Mode Dial Symbols and Functions

Symbol	Mode Name	Function
SETUP	Setup Mode	You can make and confirm your camera's settings.
	Movie Mode	You can record movies.
SCENE	Scene Mode	You can optimize the settings to shoot pictures in six scenes.
	Shooting Mode	You can shoot still images.
	Playback Mode	You can play back your movies and still images and view them on the LCD Monitor. You can also delete.



## Inserting the Batteries

The following batteries can be used in the camera. Use according to your needs.

Battery Type	Feature
AA Alkaline Batteries (LR6) (attached)	You can obtain them anywhere, so they are convenient for travel. However, in a low-temperature environment the number of shots you can take will decrease. Warm the batteries before use.
Rechargeable Battery (DB-43, DB-40) (sold separately)	This is a lithium ion battery. This is economical because you can recharge it using the battery charger BJ-2 (sold separately) and use it over and over again. They last a long time, so they are convenient for travel.
Nickel-Hydrogen Battery (available in stores)	This is economical because you can recharge it and use it over and over again. Please use a recharger available in stores.

Below is an indication of the number of images you can take. Use it as a reference.

Battery Type	Number of Shots	Number of Shots (In the Synchro-Monitor Mode : see p.18)
AA Alkaline Batteries (LR6)	approx. 50	approx. 60
Rechargeable Battery	approx. 350	approx. 400

/ The number of shots is based on a temperature of 25 degrees celsius, shooting at 30 second intervals and one out of every two being shot with the flash.

If you set the camera to the Power-Save mode, the number of shots you can take will increase. In addition to the batteries, you can use the AC Adaptor (sold separately).

Insert the batteries following these steps.

1 Slide the battery door open.

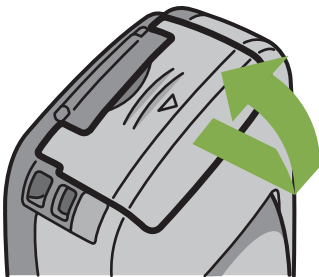

3 Slide the battery door closed.

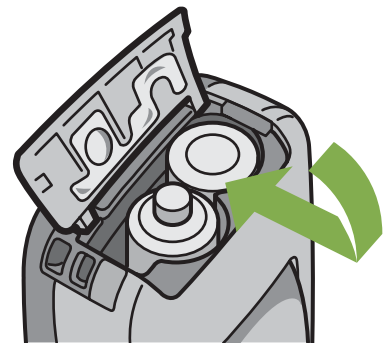

2 Insert the two batteries, making sure they are facing the correct way.

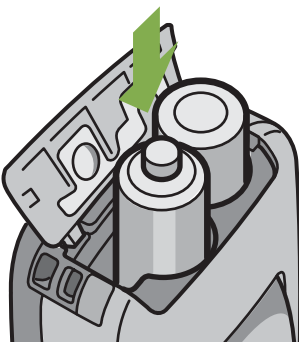

### When the batteries wear out

Just before the batteries wear out,  is displayed on the LCD Monitor. When this happens, replace the batteries with a fresh set.



- Other batteries, such as manganese dry cell (R6) and Ni-Cd cannot be used.
- Please remove the batteries if you are not going to use it for a long period of time.
- With AA Alkaline Batteries, the number of shots may differ depending on the batteries.

## Using the AC Adaptor

When shooting or viewing still images for a long time, or when connecting to your computer, use of the AC Adaptor (sold separately) is recommended.

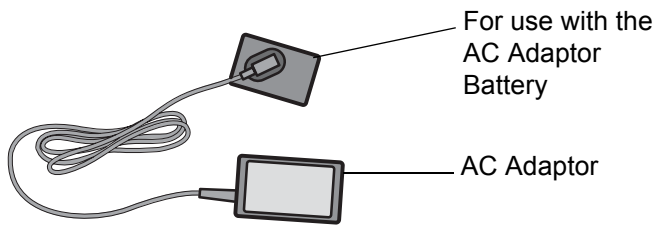

1 Make sure the camera's power is off.

2 Slide the battery door open.

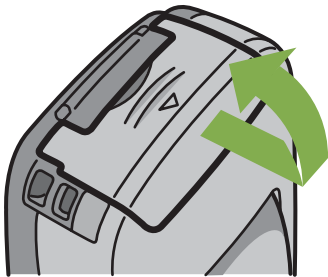

3 Insert the AC Adaptor Battery.

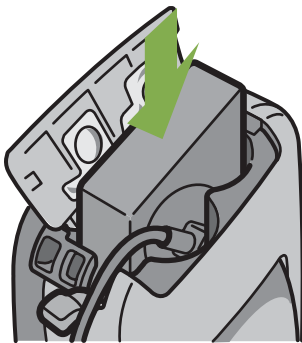

4 Open the power (DC IN) cable cover and then thread the cable out.

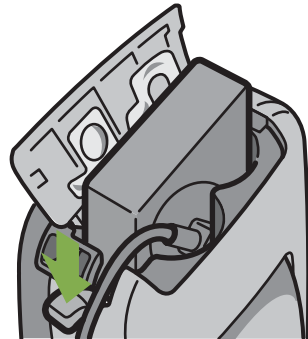

5 Slide the battery cover closed.

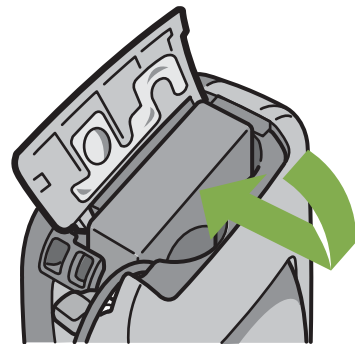

6 Plug the power cord into an outlet.

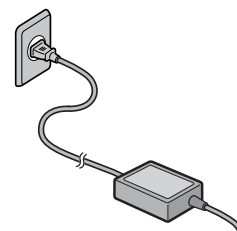

- Be sure to firmly attach cables and plug in cords.
- When you are not using the camera, unplug the AC Adaptor from the camera and the power outlet.
- While in use, if you detach the AC Adaptor or unplug it from the outlet, the data may be lost.

## Turning the Power On/Off

The camera is switched between On and Off as follows.

### ■To turn the camera On

- 1 Press the power button.

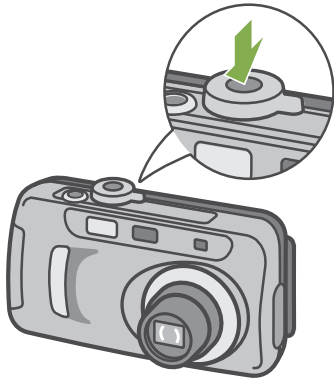

### ■To turn the camera Off

- 1 Press the power button.

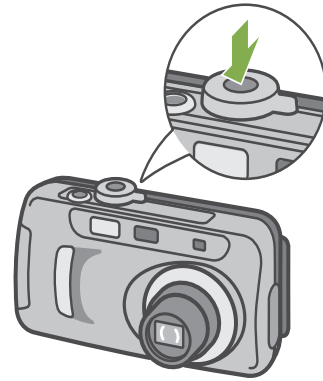

- 2 The flash lamp and auto-focus lamp will flash alternately for several seconds.



#### **Auto Power-off**

- If the camera goes unused for a set period of time, it will automatically turn itself off to save power. To use the camera again, simply press the power switch.
- At time of purchase, the Auto Power-off time is set to one minute.
- The Auto Power-off function does not work when connected to your computer.



For how to change the Auto Power-off time, see p.97.

## Setting the Date and Time

You can take still images with the time or date stamped onto the picture.

Immediately after purchasing the camera, the date and time settings will not be correct, so before using, be sure to set the date and time.

To set the date and time, follow the steps below.

Buttons used here

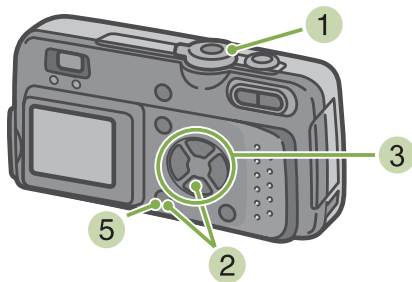

- 3 Set the year, month, date and time by pressing ▼▲▶◀.

If you hold down the ▲▼ buttons, you can increase/decrease the value quickly.



- 4 In [FORMAT], choose the Date and Time format.



- 1 Make sure the power is on and then turn the Mode Dial to SETUP (Setup Mode). The Setup screen is displayed on the LCD Monitor.
- 2 Press the ▼ button to select [DATE SETTINGS] and then press the **OK** button.

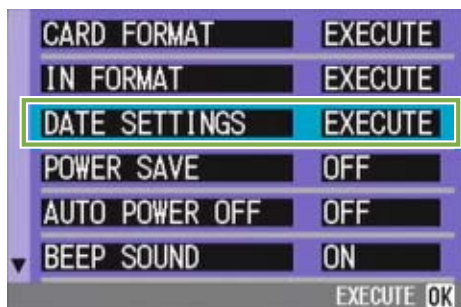

- 5 Check the display on the bottom of the screen and then press the **OK** button. Once you have set the date and time, the display returns to the Setup screen.



If the batteries are removed for about two weeks, the date and time settings will be lost. These settings must be made again.

## Inserting the SD Memory Card

You can record the still images and movies you have taken, either in the camera's internal memory or on SD Memory Cards (available in stores).



When an SD Memory Card is not inserted, the camera records images in the internal memory; when an SD Memory Card is inserted, it records images on the SD Memory Card. The internal memory capacity is 8MB.

- 3 Make sure the card is facing the right way and then push the card all the way in until it clicks.



### Where to record

When no memory card is loaded



Records to  
internal memory

When an SD Memory Card is loaded

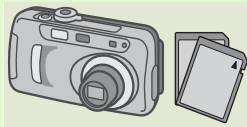

Records to SD  
Memory Card

Load the SD Memory Card according to the following steps.

- 1 Turn the power off.
- 2 Insert your finger into the notch of the card door on the side of camera and then flip the card door open.

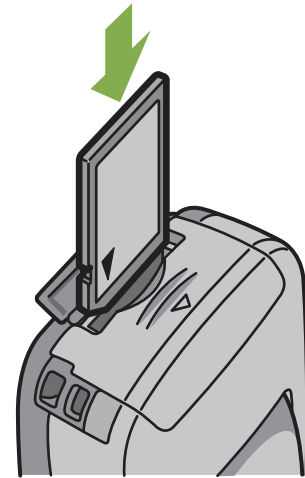
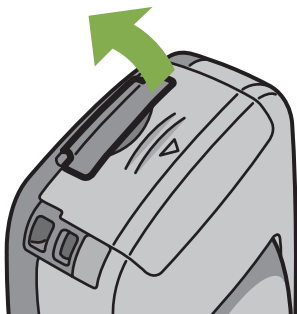

- 4 Close the card door.

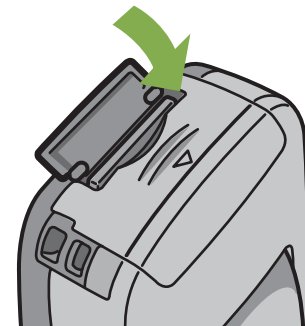

When loading the SD Memory Card, take care not to get any dirt on the card's metal parts.

## How to Use the LCD Monitor

The LCD Monitor can be used to view the subject when you are shooting an image, as well as for playing back movies and still images. Symbols and numbers indicating the camera's status and settings are displayed on the screen of the LCD Monitor.

### Screen Examples when Shooting Pictures

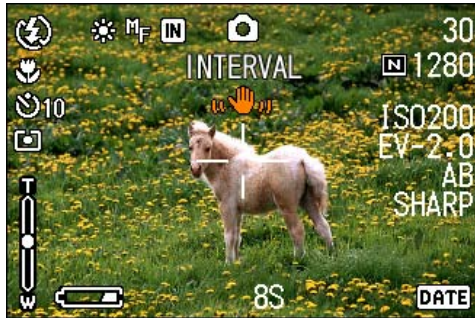

























Still Image Mode



Movie Mode

	Symbol	Display Contents	Reference Page
1. Flash	Flash Off	Current flash mode.	p.44
	Auto		
	Red-eye reduction		
	Forced Flash		
	Slow Synchro		
2. WHITE BALANCE	(No Display) AUTO	White Balance set value.	p.49
	Daylight		
	Overcast		
	Tungsten light		
	Fluoresce light		
	One-push		

	Symbol	Display Contents	Reference Page
3. FOCUS	(No Display) AF(Auto-Focus)	Focus set value.	p.55
	MF(Manual Focus)		
	 Snapshot		
	 (Infinite Telephoto)		
4. Recording Destination	 IN	Recording to internal memory.	p.13
	 SD	Recording to an SD Memory Card.	p.13
5. Flash Mode Types		Still Image Shooting Mode.	p.30
		Movie Mode.	p.39
		Multi-Shot Mode.	p.37
			p.38
			p.38
		PORTRAIT Mode.	p.33
		SPORTS Mode.	p.33
		LANDSCAPE Mode.	p.33
		NIGHTSCAPE Mode.	p.33
		Text Mode.	p.33
		HIGH SENSITIVITY Mode.	p.33
6. INTERVAL	Interval	Interval Shooting.	p.64
7. Picture Quality	 Fine	Picture Quality setting.	p.52
	 Normal		
8. Image Size	(Setting Value)	Image Size setting.	p.52
9. ISO SETTING	(Setting Value)	ISO Speed set value.	p.59
10. EXPOSURE COMP.	(Setting Value)	Exposure compensation set value.	p.47
11. SHARPNESS	SOFT	Sharpness (edge quality) set value.	p.60
	(No display) Standard		
	SHARP		
12. Date/Time	 DATE	Date Imprint mode.	p.66
13. TIME EXPOSURE	(Setting Value)	Indicates exposure time.	p.63

	Symbol	Display Contents	Reference Page
14. Shutter Speed	-	Shutter speed.	—
15. Aperture Value	-	Aperture size.	—
16. Battery	 Insufficient Capacity	Remaining Battery Power.	—
17. Zoom Bar	-	Zoom status.	p.40
18. AUTO BRACKET	AB	Auto-Bracket Shooting.	p.61
19. PHOTOMETRY	(No Display) Multi	Light Metering Method.	p.57
	 Centre		
	 Spot		
20. Self timer	 10 After 10 Seconds	Self-Timer Shooting.	p.46
	 2 After 2 Seconds		
21. Macro Shooting		Macro Shooting.	p.42
22. Remaining Number of Still Images	(Value)	Number of photos that can be taken with the current settings.	—
23. Remaining Recording Time	(Value)	Length of time remaining for shooting with the current settings.	—
24. Recording Time	(Value)	Amount of time recorded.	—
25. Message	-	Message about an operation or the camera's status.	—
26. camera shake		May be displayed while adjusting focus.	—



When shooting in particularly bright places, you may not be able to prevent overexposure. In this case, the [!AE] symbol will be displayed.



## The Screen During Playback



Still Image Mode



Movie Mode

	Symbol	Display Contents	Reference Page
1. PROTECT		Protected status.	p.85
2. Playback data source		Indicates playback from internal memory.	p.13
		Indicates playback from an SD Memory Card.	p.13
3. Mode Types		You are in Shooting Mode or Scene Mode.	p.74
		Movie Mode.	p.76
4. Number of Playback Files		The number of the file being played back.	—
5. Total number of files		Total number of files recorded.	—
6. Picture Quality	Fine	Picture Quality setting.	p.52
	Normal		
7. Image Size	(Setting Value)	Image size.	p.52
8. Folder No	-	Number of the folder in which the file is saved.	—
9. File No	-	Number of the file being played back.	—
10. Shutter Speed	-	Shutter speed.	—
11. Aperture Value	-	Aperture size.	—
12. Battery	Insufficient Capacity	Remaining battery level.	—
13. PRINT		DPOF specified.	p.90
14. Indicator		Elapsed time of movie playback.	—
15. Playback Time	(Time)	Movie playback time.	—
16. Message	-	Message about an operation or the camera's status.	—



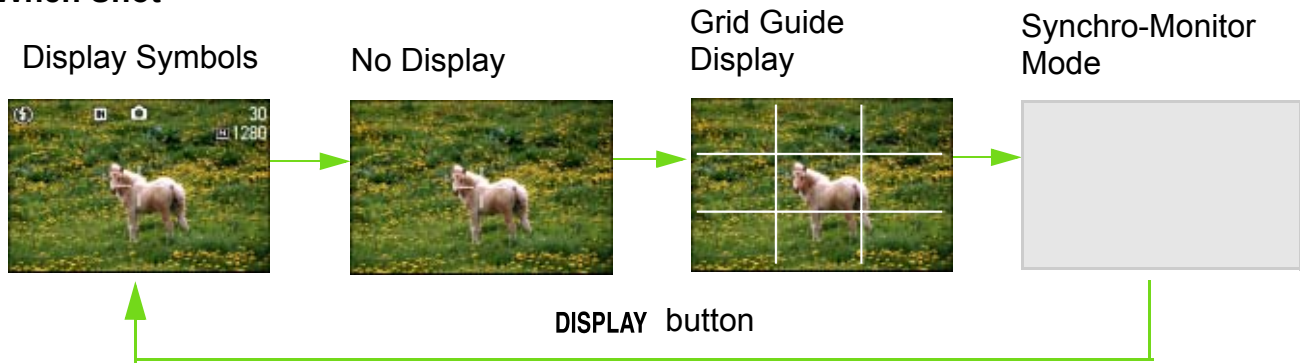

## Switching the Screen Display

If you press **DISPLAY**, you can change the screen display mode, such as switching between display/no display of symbols, etc.



### ■When Shot



In the Synchro-Monitor Mode except with the following operations, the LCD Monitor is turned off (No Display). This is a useful mode to reduce power consumption.

- Half-press the shutter button.  
The LCD Monitor is turned on and you can confirm composition. After you finish shooting with Full-Press, the LCD Monitor will automatically turn off.
- Press the  (Quick Review) button.  
You can view the photo you just took (see p.71). By pressing the  (Quick Review) button again, you can turn the LCD Monitor off.
- Press the **MENU** button.  
The LCD Monitor Display is turned on and you can make various settings for shooting (see p.24). By pressing the **MENU** button again, you can turn the LCD Monitor off.
- You cannot turn the LCD Monitor Display on/off by pressing  (Self-timer),  (Flash) or  (Macro) buttons.
- Turning the LCD Monitor Display Off conserves battery life. In this case, shoot using just the Viewfinder.



When the No Display or Grid Guide Display is on, symbols will appear only for a few seconds right after pressing ,  (Flash) or  (Macro) buttons.



For how to display the grid guide, see p.68.

### ■When Playing Back

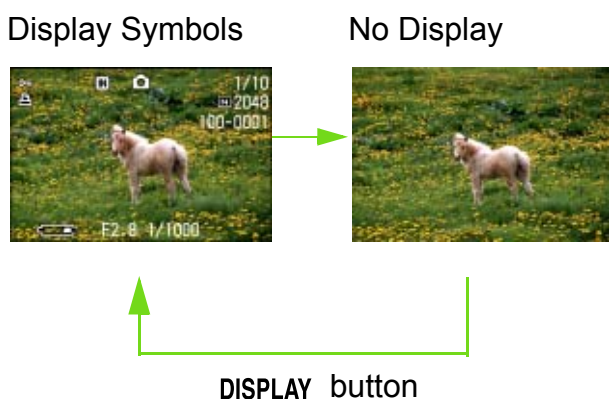

## Button Functions

The following table summarizes the functions of the camera's buttons.



Power Button, see p.11.  
Mode Dial, see p.8.  
Shutter Button, see p.30.

Button	Function
(Delete)/ (Self-timer) Button	<p>If you press the button in Shooting Mode, self-timer mode is activated and you can take photos using the self-timer (see p.46).</p> <p>If you press the button during Playback Mode, you can delete the still image or movie that is displayed on the LCD Monitor (see p.82).</p>
When in the Shooting Mode (Flash) Button (Macro) Button (Quick Review) Button	<p>Switches between Flash/Flash Off and other Modes (see p.44).</p> <p>You can take close-ups (see p.42).</p> <p>The last still image you took is displayed (see p.71).</p>
In the Playback Mode (Full-Screen Display) Button Button	<p>Displays the previous still image or movie (see p.74).</p> <p>Displays the next still image or movie (see p.74).</p>
In the Playback Mode (Thumbnail Display) Button	<p>Displays the still image (or movie) on the right, left, above or below (see p.77).</p>
When the menu is displayed Button	<p>Moves the frame left, right, up and down (see p.24).</p>
(Wide-angle)/ (Thumbnail Display) Button	<p>If you press the button in Shooting Mode, you can shoot with the wide-angle zoom (see p.40).</p> <p>If you press the button in Playback Mode, the LCD Monitor display is split, allowing you to see sets of still images at one glance (6 images at once) (see p.70).</p>
(Telephoto)/ (Enlarged View) Button	<p>If you press the button in Shooting Mode, you can shoot with the telephoto zoom (see p.40).</p> <p>If you press the button in Playback Mode, image is displayed on the LCD Monitor up to 3.4 times larger (see p.78).</p>
<b>DISPLAY</b> Button	<p>Switches the display of symbols on the LCD Monitor (see p.18).</p>
<b>OK</b> Button	<p>This button is used for menu operations (see p.20) displayed on the LCD.</p>
<b>MENU</b> Button	<p>This button is used for setting the various shooting methods (see p.20), or downloading still images onto your computer.</p>

## Screens

Default values set when you purchased your camera are surrounded by brackets [ ] in the selection options.

### ■ Shooting Menu (Shooting Mode)

In Shooting Mode, display by pressing the **MENU** button.





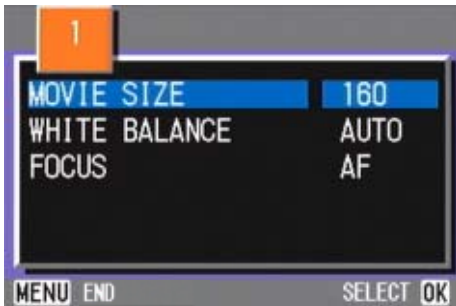

Setting	Option	Reference Page
EXPOSURE COMP.	-2 ~ +2	p.47
WHITE BALANCE	[AUTO] /  (Daylight) /  (Overcast) /  (Tungsten light) /  (Fluorescent light) /  (One Push)	p.49
PIC QUALITY/SIZE	F2048/N2048/F1280/[N1280]/N640	p.52
FOCUS	[AF]/MF/SNAP/∞	p.55
CONT. MODE	[OFF]/CONT/SCONT/MCONT	p.36
PHOTOMETRY	[MULTI]/CENTRE/SPOT	p.57
ISO SETTING	[AUTO]/ISO200/ISO400/ISO800	p.59
SHARPNESS	SHARP/[NORMAL]/SOFT	p.60
AUTO BRACKET	ON/[OFF]	p.61
TIME EXPOSURE	[OFF]/1/2/4/8 seconds	p.63
INTERVAL		p.64
DATE IMPRINT	[Off]/Date/Date and Time	p.66
RESTORE DEFAULTS		p.67

## ■ Shooting Menu (Movie Mode)

In Movie Mode, display by pressing the **MENU** button.







Setting	Option	Reference Page
MOVIE SIZE	[320×240] / 160×120	p.39
WHITE BALANCE	[AUTO] /  (Daylight)/  (Overcast)/  (Tungsten light)/  (Fluorescent light)/  (One Push)	p.49
FOCUS	[AF]/MF/SNAP/∞	p.55

## ■ Shooting Menu (Scene Mode/except in Text Mode)

In Scene Mode, display by pressing the **MENU** button.



Setting	Option	Reference Page
WHITE BALANCE	[AUTO] /  (Daylight)/  (Overcast)/  (Tungsten light)/  (Fluorescent light)/  (One Push)	p.52
PIC QUALITY/SIZE	F2048/N2048/F1280/N1280/N640	p.49
FOCUS	[AF]/SNAP/∞ (except the Landscape Mode)	p.55

## ■ Shooting Menu (Text Mode)

In Text Mode, display by pressing the **MENU** button.



Setting	Option	Reference Page
DENSITY	DEEP/[NORMAL]/LIGHT	p.69

## ■ Playback Menu

In Playback Mode, display by pressing the **MENU** button.



Setting	Option	Reference Page
SLIDE SHOW	ON/[OFF]	p.79
PROTECT	Select/Release 1 FILE/ Select/Release ALL FILES	p.85
PRINT	Select/Release 1 FILE/ Select/Release ALL FILES	p.90
COPY TO CARD	_____	p.89

## ■ Scene Selection Screen (Scene Mode)

In Scene Mode, the screen is displayed when you select a scene.



Symbol	Setting Content	Reference Page
	PORTRAIT	p.33
	SPORTS	p.33
	LANDSCAPE	p.33
	NIGHTSCAPE	p.33
	TEXT MODE	p.33
	HIGH SENSITIVITY	p.33

## ■ Setup Screen (Setup Mode)

This screen is displayed in Setup Mode.

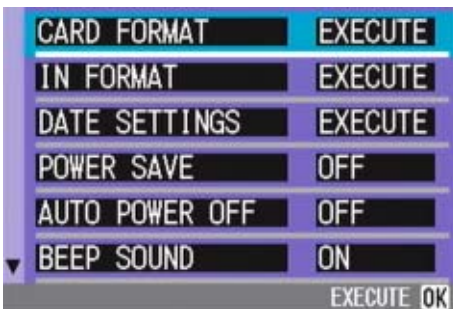

Setting	Option	Reference Page
CARD FORMAT	_____	p.94
IN FORMAT	_____	p.95
DATE SETTINGS	_____	p.12
POWER SAVE	ON/[OFF]	p.96
AUTO POWER OFF	OFF/[1]/5/30 Minutes	p.97
BEEP SOUND	[ON]/OFF	p.98
SEQUENTIAL NO.	ON/[OFF]	p.99
IMAGE CONFIRMATION TIME	OFF/[1]/2/3 Seconds	p.100
LCD BRIGHTNESS	_____	p.101
LANGUAGE	JPN/[ENG]/FRE/GER/CHI	p.102
VIDEO OUT MODE	[NTSC]/PAL	p.103



## The Basics of the Shooting Menu/Playback Menu

To display the menu:

- 1 Turn the Mode Dial to (Shooting Mode) or (Playback Mode).
- 2 Press the **MENU** button.

The menu appears. On the menu screen, you can move between screens by pressing the buttons and between items by pressing the buttons.

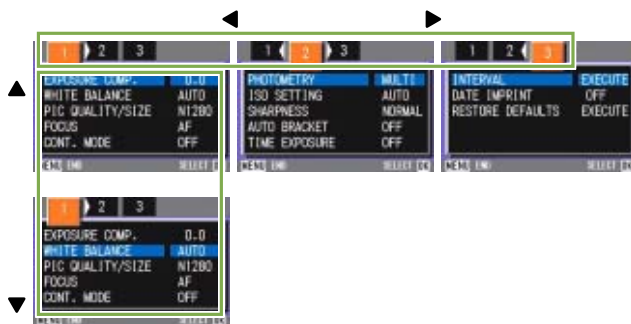

To switch between menu screens (Shooting Menu):

- 1 Press the buttons.  
You can switch the menu screen from [1] to [3].

To select an item:

- 1 Press the buttons to select the desired item.
- 2 Press the **OK** button.

To select a setting value (shooting menu):

- 1 Press the buttons to select the desired item.
- 2 Press the **OK** button.

To implement a confirmation screen (shooting menu):

- 1 Press the button to select [YES].
- 2 Press the **OK** button.

To select an item you want to implement (playback menu):

- 1 Press the buttons to select the item you want to implement.
- 2 Press the **OK** button.

To return to the shooting screen/playback screen:

- 1 Press the **MENU** button.



- On the setting selection screen, the item with the orange displayed is the current setting. Even if you change the setting by moving the blue indicator, until you finalize the setting the orange indicator remains to show what the previous setting was.



- The menu screen sequence is slightly different depending on the item for which the setting change is being made. For a detailed explanation of each of the items, see Section 2 (p.26-42) or Section 3 (p.43-69).



## The Basics of the Setup Screen

To display the Setup Screen:

- 1 Turn the Mode Dial to SETUP (Setup Mode).  
The Setup Screen is displayed.

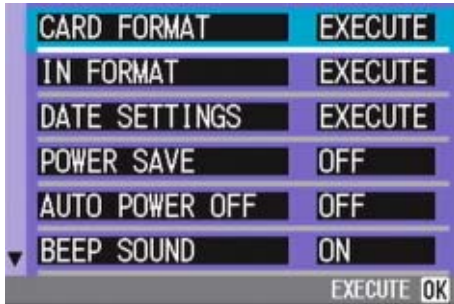

To select an item:

- 1 Press the ▲▼ buttons to select the desired item.

To select a setting value:

- 1 Press the ◀▶ buttons to select the desired item.

When you have selected [EXECUTE]:

- 1 Press the **OK** button.
- 2 The following screen is displayed, so make the necessary settings.

To close the Setup Screen:

- 1 Switch the Mode Dial to another mode.



The sequence of operations is slightly different depending on the item for which the setting change is being made. For a detailed explanation of each of the items, see Section 6 (p.93-103).



# Section 2 Basic Shooting

---

The basics of shooting are explained here, from how to hold your camera to how to shoot still images and movies.

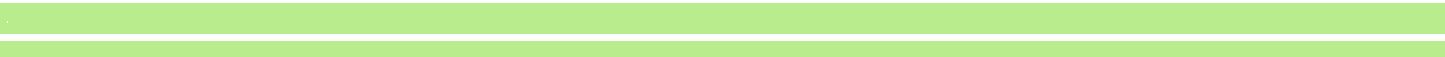

## How to Hold the Camera

If the camera moves when you press the shutter button, your still images won't come out clearly (camera shake).

Hold the camera as below and you'll get a better result.

- 1 Hold the camera with both hands and lightly press both elbows against your body.

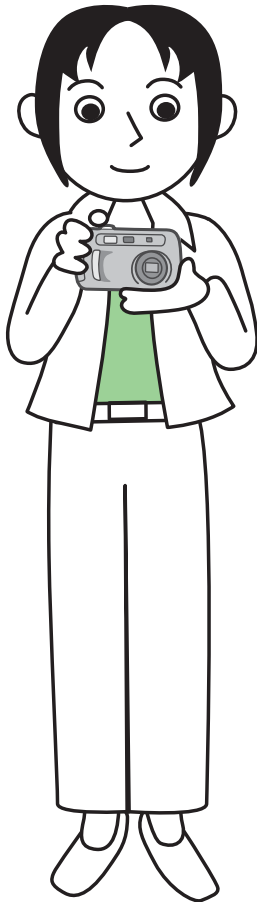

- 2 Put your finger on the shutter button

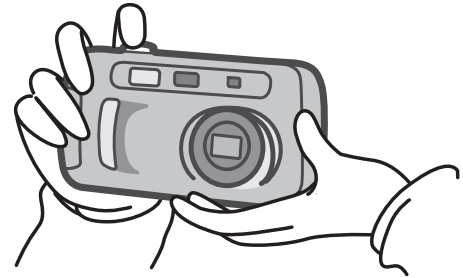

- Be careful when you are shooting not to get a finger, your hair, or the strap in front of the lens or the flash.
- To prevent camera shake, hold the camera securely with both hands when you shoot or use a tripod. Consider using a tripod to prevent camera shake in the following situations:
  - When shooting in a dark place, if you do not use the flash or if you use the Slow Synchro mode.
  - When you shoot with the zoom.

## How to Focus

The range displayed on the LCD Monitor is shot as a still image or a movie. When adjusting focus, press the shutter button halfway (half-press).

To adjust focus, follow the steps below.

- 1 Point the lens toward the subject you want to shoot.
- 2 Compose the picture on the LCD Monitor.
- 3 The focus is set at the center of the screen, so use the screen to center your subject.

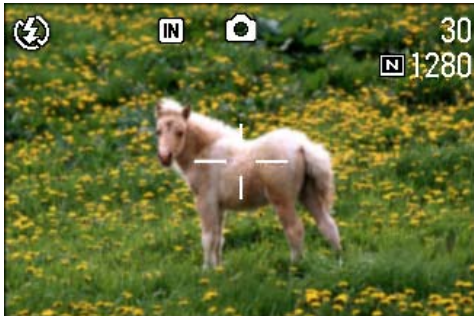

- 4 Half-press the shutter button.

F stop (aperture size) and shutter speed are displayed in the bottom part of the screen, and the camera focuses.

Once the shot is in focus, the exposure and white balance are fixed and the crosshair in the center of the LCD Monitor turns green, as does the auto-focus lamp in the lower left of the Viewfinder. Check one of these to make sure the subject is in focus.

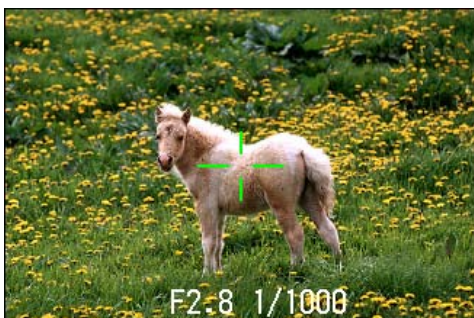

If it cannot focus, the crosshair in the center of the LCD Monitor turns red.

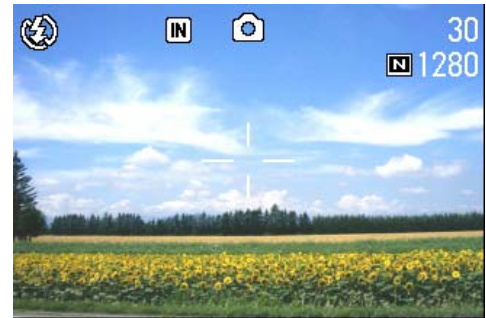

Before focusing



When the shot is in focus

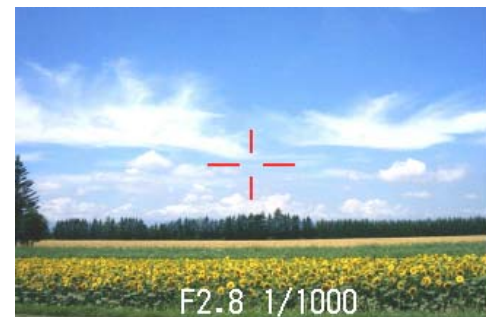

If the camera did not focus



If the subject is not centered on your composition, see p.32.



- There is another shooting method, which is to fully depress the shutter once, without using the half-press method. full-press shooting is effective for capturing the moment. However, you cannot check that your shot is in focus while shooting. (see p.31)
- If you turn the LCD Monitor off (see p.96) and use the Viewfinder for shooting, the battery will last longer. However, if you do so, you will not be able to check the focus. Also, the range you can see in the Viewfinder and the range of what is shot, may differ slightly, depending on shooting distance. When you want to be sure that the focus or the shooting range are just right for your shot, it is recommended that you use the Viewfinder.

## Shooting Still Images

Use the Shooting Mode when you take your still images. There are two methods of using the shutter button, pressing the shutter in two stages (half-press) and pressing it all the way down at once (full-press).

When you use half-press, you can confirm that your shot is in focus on the LCD Monitor. When you want to capture the moment, full-press is convenient.



- For how to shoot with Zoom, see p.40
- For how to shoot Close-ups, see p.42

### Check the Focus and Shoot (Half-press)

Buttons used here

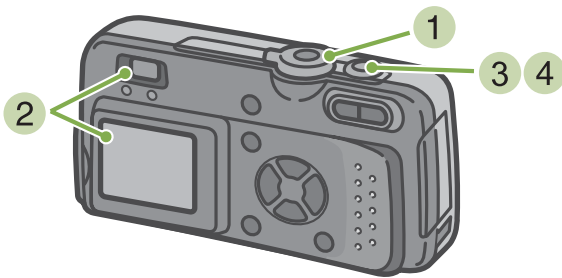

- Put the subject of your photo right in the center and press the shutter button half-way. F stop (aperture size) and shutter speed are displayed in the bottom part of the screen, and the camera focuses.

Once the shot is in focus, the exposure and white balance are fixed and the crosshair in the center of the LCD Monitor turns green, as does the auto-focus lamp in the lower left of the Viewfinder. Check one of these to make sure the subject is in focus.



- Gently press the shutter button all the way. The still image you have taken freezes for a moment on the LCD Monitor and is recorded.

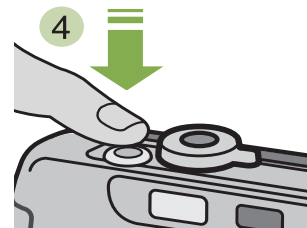

- When the image confirmation time is set to OFF, it is not displayed. See p.100.

## Capture the Moment Shooting (Full-press)

Buttons used here

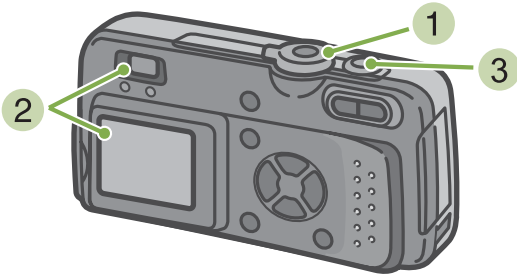

- Put the subject of your photo right in the center and press the shutter button all the way.

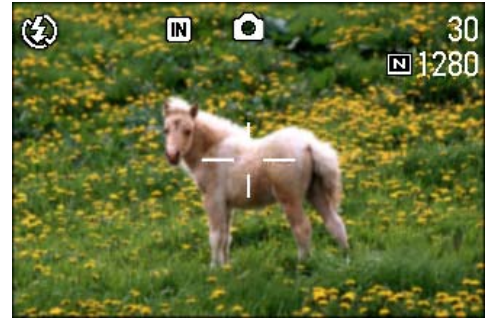

After the camera focuses automatically, the still image is taken and recorded.

- Turn the Mode Dial to  (Shooting Mode).
- Compose your shot either by looking through the Viewfinder or at the LCD Monitor.



- Certain subjects are hard to bring into focus:

It may be impossible to bring the following kinds of subjects into focus.

- Subjects lacking contrast (the sky, a white wall, the hood of a car, etc.)
- Flat two-dimensional objects with only horizontal lines and no significant protrusions
- Quickly moving objects
- Things in poorly lit places
- Areas with strong backlighting, or reflections
- Things that flicker, such as fluorescent lights

When you want to shoot subjects like this, first focus on an object the same distance as your subject and then shoot. (see p.32)

- When shooting in focus-poor conditions, it is recommended you use the Half-Press method.



## When the Subject is not Centered on Your Composition (Focus Lock)

When the subject of your composition is not centered, you can compose your picture after setting the focus and then shoot. This method is called "Focus-Lock."

Buttons used here

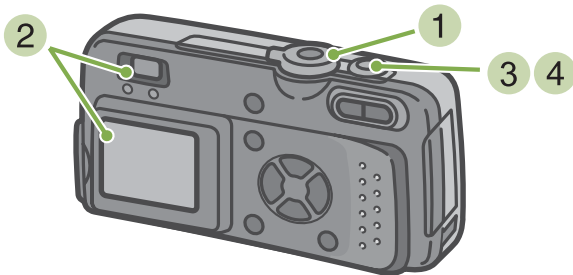

- 3 With the shutter half-pressed, compose your shot.

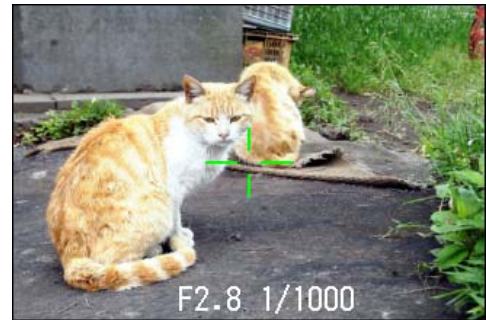

- 4 Gently press the shutter button all the way.

- 1 Turn the Mode Dial to (Shooting Mode).
- 2 Put the subject of your photo right in the center of the LCD Monitor or the Viewfinder and press the shutter button half-way. F stop (aperture size) and shutter speed are displayed in the bottom part of the screen, and the camera focuses.

Once the shot is in focus, the exposure and white balance are fixed and the crosshair in the center of the LCD Monitor turns green, as does the auto-focus lamp in the lower left of the Viewfinder. Check one of these to make sure the subject is in focus.

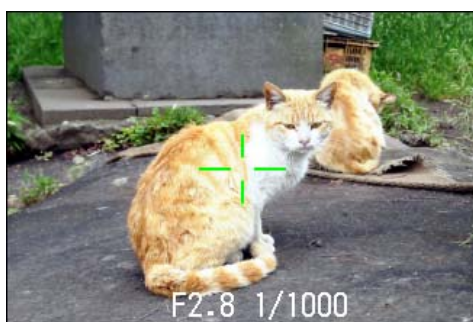



## Shooting with Scenery-Matching

If you use the Scene Mode, you can select from among six types of shooting modes and shoot automatically with optimal settings for the scene.

You can select a mode from the following six types, in Scene Mode.

### PORTRAIT

This is best for taking pictures of people.

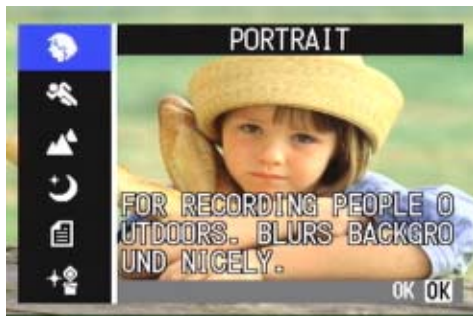

### NIGHTSCAPE

Use when shooting night scenes. You can also shoot with people in the frame.



### SPORTS

This is best for pictures of moving objects.

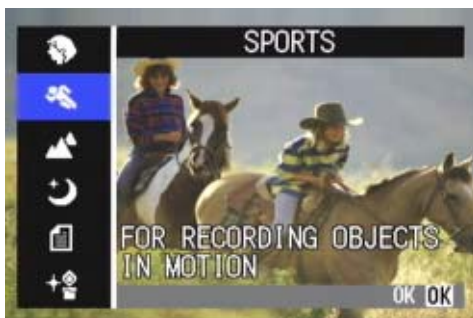

### TEXT MODE

This is best for black and white subjects like printed documents. These still images are recorded as TIFF format Files.

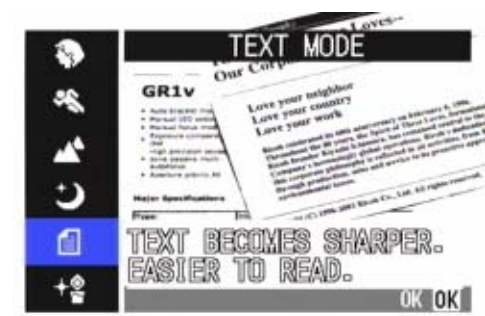

### LANDSCAPE

This is best for scenery with a lot of blue sky or greenery.



### HIGH SENSITIVITY

This is best for taking pictures in dimly lit places.



- You can set White Balance while in Scene Mode as well (see p.49), but it may not be possible to get the effect that matches a scene.
- Manual focus cannot be used in Scene Mode.
- In Scene Mode, those pictures displayed in the background of the explanation screen are just for effect.

To use Scene Mode, follow the steps below.

#### Buttons used here

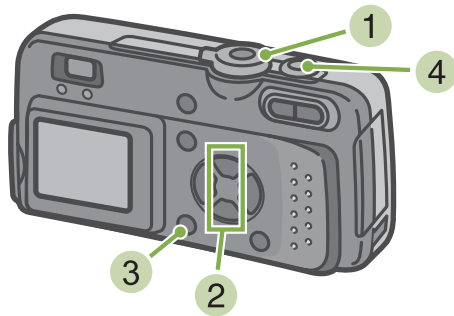

- 1 Turn the Mode Dial to SCENE (Scene Mode).  
The scene selection screen appears.

- 2 Press the ▲▼ buttons to select the mode you want to use.



- 3 Press the **OK** button.  
The camera switches to the Scene Mode shooting screen and the symbol of the Mode you selected is displayed in the top of the screen.



If you press the ▶ button, the scene selection screen is displayed and you can change the mode.

If you press **MENU** button, the shooting menu appears.

- 4 Press the shutter button.



- If you switch the Mode Dial to  (Shooting Mode), you can operate Shooting Mode as usual.
- If you return to Scene Mode again, the scene selection screen as previously used is displayed.
- In Text Mode, Image Size cannot be set to 640 × 480, 2048 × 1536 pixels. If a photo is taken with the 640 × 480, 2048 × 1536 setting, the size automatically becomes 1280 × 960 pixels.



- When you want to change PIC QUALITY/SIZE in PORTRAIT/SPORTS/LANDSCAPE/NIGHTSCAPE/HIGH SENSITIVITY Modes, see p.52
- To make changes to density in TEXT Mode, see p.69.
- To change the focus setting to manual or other, see p.55.
- To make changes to the White Balance settings, see p.49.



#### TIFF File

This is read "tiff" file. This is a file format for saving image data.  
The file size is larger than with JPEG (jay-peg) format.

## Combination of Scene Mode and Function

Depending on the Scene Mode, the way functions work may differ from when in normal shooting mode. Refer to the table below.

Mode Name	Flash	Macro Shooting
PORTRAIT	Initial setting: Flash Off	Disabled
SPORTS	Initial setting: Flash Off	Disabled
LANDSCAPE	Fixed on Flash Off	Disabled
NIGHTSCAPE	Forced flash is disabled	Disabled
	Initial setting: Auto	
TEXT MODE	Initial setting: Flash Off	Enabled
HIGH SENSITIVITY	Initial setting: Flash Off	Enabled

## Shooting with Multi-Shot

If you switch to Multi-Shot, you can shoot consecutive images.

This is convenient when you want to capture the moment.

There are three ways to shoot Multi-Shots, "CONT", "SCONT" and "MCONT".

### CONT (Multi-Shot)

As long as you hold the shutter button down, pictures continue to be taken.

The still images are recorded one file each, just as in normal shooting.



### SCONT (S Multi-Shot)

Shoots a continuous stream of images. With just one full-press of the shutter, you can take 16 consecutive shots at 1/7.5 of a second intervals (about two seconds).

The 16 still images are grouped together as a set and are recorded as one image file.



### MCONT (M Multi-Shot)

The camera memorizes the scene while you hold the Shutter Button down, and once you release it the previous two seconds of shots are recorded.

The 16 still images are grouped together as a set and are recorded as one image file.



- The shooting time differs according to image size.
- While shooting with Multi-Shot, the LCD Monitor display turns off. Compose your picture and secure it using a tripod, or use the Viewfinder.
- The Picture Quality Mode and the Image Size Mode of SCONT/MCONT is N2048.

## Making Multi-Shot Settings (CONT. MODE)

To make Multi-Shot settings, follow the steps below.

Buttons used here

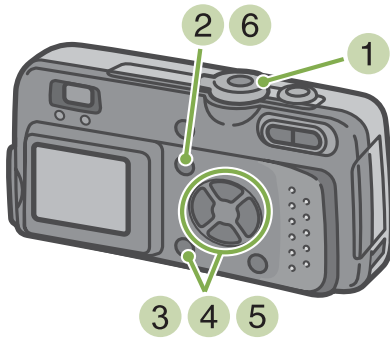

- 1 Turn the Mode Dial to (Shooting Mode).
- 2 Press the **MENU** button.  
The Shooting menu is displayed.
- 3 Select [CONT. MODE] and press the **OK** button.

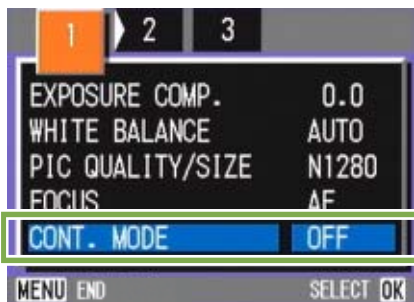

- 4 Press the **▲▼** buttons to select [CONT], [SCONT], or [MCONT].

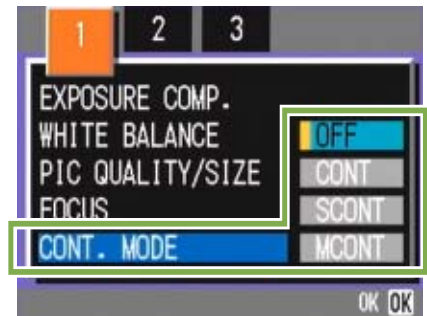

- 5 Press the **OK** button.
- 6 Press the **MENU** button.  
The Shooting Menu closes and the symbol is displayed above the screen.



- When you want to return to normal single shot shooting, follow step 2, select [OFF] with step 3 and press the **OK** button.
- The flash cannot be used.



## Shooting with Multi-Shot

Buttons used here

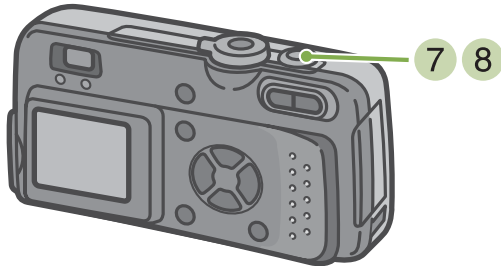

Operation continued from the previous page:

- 7 Compose your picture, then press and hold the shutter button.  
As long as you hold the shutter button down, pictures continue to be taken.
- 8 As soon as you release the shutter button, shooting stops.

## Shooting with S Multi-Shot

Buttons used here

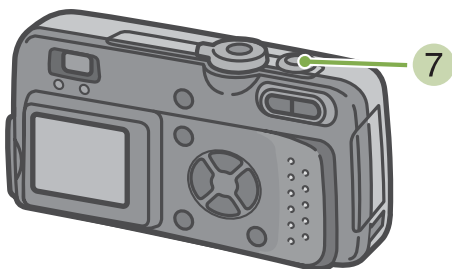

Operation continued from the previous page:

- 7 Compose your picture, then press the shutter button.  
16 pictures are taken automatically.

## Shooting with M Multi-Shot

Buttons used here

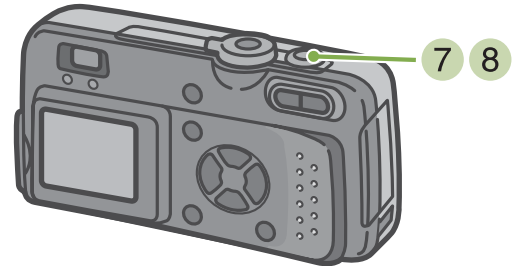

Operation continued from the previous page:

- 7 Compose your picture, then press and hold the shutter button.  
Storing to memory begins.
- 8 Release your finger from the shutter button.  
The camera takes images in memory from two seconds prior up to release of the shutter button.



If you release the shutter button within two seconds from the time you first pressed it, the shots from the time you pressed the shutter until you released it will be recorded (the number of consecutive shots will be less than 16).

## Shooting Movies

You can shoot movies. You can select the image size, either 320 × 240, or 160 × 120 pixels. The maximum shooting time of each is 30 seconds (320 × 240) and 120 seconds (160 × 120). Each movie you shoot is recorded as one AVI file.

To shoot a movie, follow the steps below.

Buttons used here

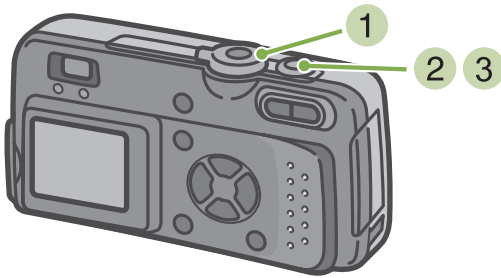

### 2 Press the shutter button.

Your movie begins shooting.

Shooting continues until you press the shutter button again.



### 3 Pressing the shutter button again stops recording.

### 1 Turn the Mode Dial to (Movie Mode).



- Flash cannot be used.
- While shooting movies, only Digital Zoom can be used.



- To change the image size for movies, see p.52.
- For how to use the Flash, see p.44.
- For how to use the zoom function, see p.40.
- For how to use the Digital Zoom, see p.41.





#### AVI File

This is read "A-V-I" file.

This is a file format used to save movie data.

## Shooting with the Zoom

If you use the  (Telephoto):T/  (Wide-angle):W buttons, you can alter the size of the subject in your photo without having to change distance from the subject. (Equivalent to a 35mm camera's 35 to 105mm zoom.)

By pressing the  (Telephoto) button, the subject you see in the LCD Monitor and the Viewfinder becomes larger.

By pressing the  (Wide-Angle) button, the field in the LCD Monitor and the Viewfinder becomes wider.



Telephoto Zoom





Wide-angle Zoom

To shoot with the zoom, follow the steps below.

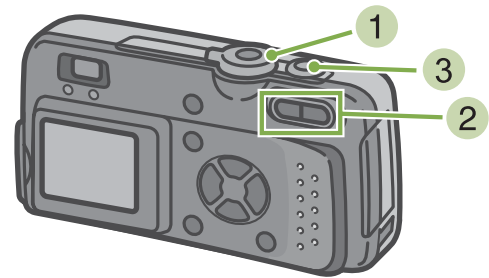
Buttons used here



- 1 Turn the Mode Dial to  (Shooting Mode).
- 2 Compose your picture while viewing either the LCD Monitor or the Viewfinder and zoom by pressing either the  button, or the  button.

A bar is displayed in the LCD Monitor indicating Zoom status.



- 3 Press the shutter button.





## Shooting with the Digital Zoom

The Digital Zoom function enlarges images by processing them. When you use the digital zoom, pressing the  (Telephoto) button enlarges the subject even more than the specified enlargement ratio (optical zoom). (Maximum of 3.4 magnification.)

To shoot with the Digital Zoom, follow the steps below.

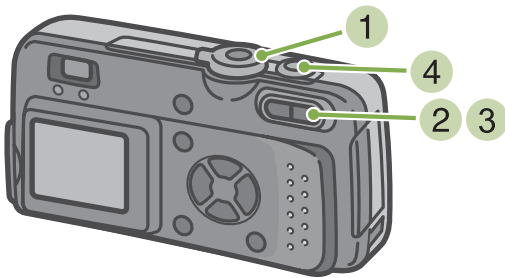
Buttons used here





- 1 Turn the Mode Dial to  (Shooting Mode).

- 2 Zoom in to the maximum by pressing the  button, while viewing through the LCD Monitor.

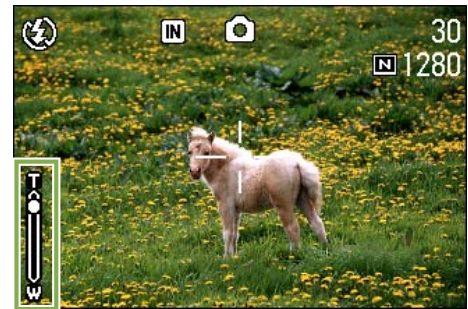
A bar is displayed in the LCD Monitor indicating Zoom status.



- 3 When you have enlarged to the limit of the zoom bar at the T (telephoto) end, release the  button once and continue pressing the  button.

The digital zoom is activated and the subject becomes larger.



- 4 Press the shutter button.



- The more you enlarge with the digital zoom, the lower the picture quality becomes.
- When using the digital zoom, compose your shot on the LCD Monitor.
- If you use the Mode Dial to change mode, the digital zoom setting is lost.
- To release the digital zoom, press the  (Wide-angle) button.
- Digital zoom cannot be used in TEXT MODE.



### Optical Zoom

This function enlarges your subject by moving the lens, thus changing the focal length.

## Shooting Close-ups (Macro Photo)

If you use the  (Macro) button, you can get up close with the lens and take a photo (Macro Photo). This is good for shooting flowers, insects and other small subjects, because you can get a close-up of one centimeter (1/2 inch) from your subject.

To shoot close-ups, follow the steps below.

Buttons used here

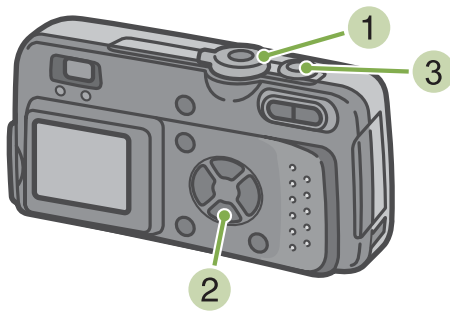

- 2 Press the  (Macro) button.

The Macro symbol is displayed on the left side of the screen.



- 3 Press the shutter button.

- 1 Turn the Mode Dial to  (Shooting Mode).



- When using the zoom, you can shoot close-ups up to the following distances.

In Wide-Angle (W): Closest 1cm

In Telephoto (T) : Closest 16cm

- To get out of Macro Mode, press the  (Macro) button again.
- During Macro Shooting, the Viewfinder cannot be used. Use the LCD Monitor.



For how to use the Wide-angle Zoom, see p.40.



# Section 3 Using Special Features for Improved Photography

---

This section describes how to change the various shooting-related settings.

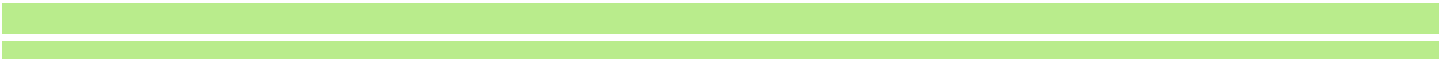





## Using the Flash

If you press the ⚡ (Flash) button, you can switch into Flash Mode (Flash, Flash Off, and other settings). Switch settings according to time, conditions and your preference, and shoot your pictures. The light of the flash can reach the following distances: in wide-angle, about 0.2 to 4.5 m, in telephoto, approximately 0.16 to 2.5 m.

You can check your Flash Mode setting by the symbol displayed on the upper left of the LCD Monitor.

[Flash Mode Types]

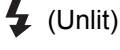
Symbol	Mode Name	Description
	Flash Off	The flash will not fire. Use when shooting at place flash is prohibited or when shooting with indoor lighting.
	Auto	When your subject is poorly lit or backlit, the flash fires automatically.
	Red-eye reduction	When shooting images of people, the red-eye phenomenon, in which people's eyes appear red, is reduced.
	Forced Flash	The flash fires, whatever the light conditions are, when you shoot. Use when there is backlighting when shooting outside in daylight.
	Slow Synchro	The flash fires with the shutter speed slowed. Use when shooting images of people against a nightscape.

To switch to Flash Mode, follow the steps below.

Buttons used here

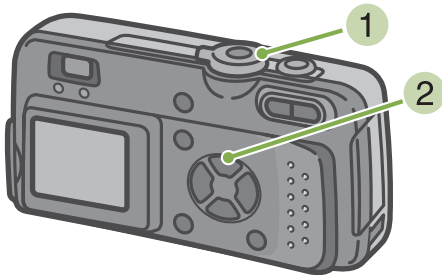

- Pressing the ⚡ (Flash) button switches to Flash Mode.



The flash starts recharging. While the flash is charging, the LCD Monitor goes off and the flash lamp blinks. Once charging is complete, the lamp is steadily lit and it is possible to shoot.

- Turn the Mode Dial to  (Shooting Mode).  
Alternatively, turn the Mode Dial to SCENE (Scene Mode), and select a scene to have the camera ready.



## Slow Synchronized

When you shoot pictures in dark places and want to capture background as well, use this mode, which slows shutter speed and sets the flash to Flash Off.

### Red-Eye

If you shoot with the flash in a dark place, people's eyes will appear red. This is called the "red-eye" phenomenon.



- At purchase your camera is set to Flash Off.
- The settings are saved until you press the  (Flash) button to change them.
- When shooting movies or in Multi-Shot mode, the setting becomes Flash Off.
- When the camera is set to Flash Off or Slow Synchro Mode, the shutter speed is slowed, so the camera is subject to camera shake. Hold the camera firmly with both hands and shoot.
- When in LANDSCAPE of Scene Mode, the flash setting is fixed to Flash Off.
- When in NIGHTSCAPE of Scene Mode, Forced Flash cannot be selected. Also, the initial setting value is Auto.
- If you press the flash button, even while the flash is charging, you can return to Flash Off mode. If you do this, flash charging is cancelled.

## Using the Self-Timer

You can set the Self-timer to shoot after either two or ten seconds. If the person who takes the photo wants to be in the still image as well, it is convenient to use a setting of ten seconds; a setting of two seconds is useful for preventing camera shake. Attach a tripod securely to the tripod mount on the bottom of the camera.

To shoot with the Self-timer, follow the steps below.

Buttons used here

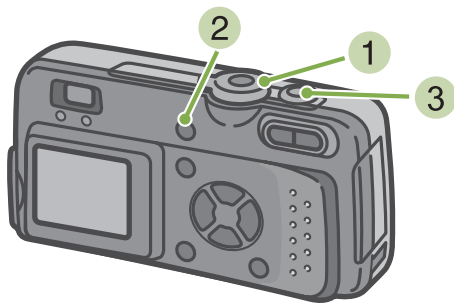

### 2 Press the (Self-timer) button.

The Self-timer mode is switched on and the Self-timer symbol is displayed.

The "10" to the right of the symbol indicates the number of seconds. In this case, if you press the shutter button, the camera will shoot after 10 seconds.

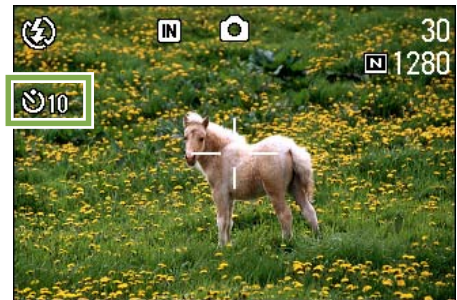

### 3 Press the shutter button.

The flash begins to blink and the Self-timer starts. After about ten seconds the camera shoots. About two seconds before the camera shoots the audio tone beeps.

After shooting, Self-timer mode switches off.

### 1 Turn the Mode Dial to (Shooting Mode).



- Each press of the  (Self-timer) button, it selects a function in the following sequence: 10 sec, 2 sec, Self-timer Off, 10 sec, 2 sec...
- Self-timer settings are released when the power is turned off.
- The focus is fixed when the shutter button is pressed.

## Changing the Exposure (EXPOSURE COMP.)

The exposure setting allows you to select brightness levels for your shots.

Normally, if your subject is centered, backlight compensation is automatically activated, and you can shoot with correct exposure. However, in the following cases, or when you intentionally want to change the exposure, you can change the exposure setting. Exposure can be specified in the range of -2.0 and +2.0.

### For Backlighting

When the background is particularly bright, the subject will be dark (under-exposure).



### When your subject is whitish

When you photograph a subject that is mainly white, it will turn out entirely dark, with people appearing dark, and white objects appearing greyish.



### When your subject is darkish

When you photograph a subject that is mainly dark, it will turn out entirely bright (over-exposure), with people appearing white, and black objects appearing greyish. The same happens when you take photos of people in a spotlight.





To make changes to exposure settings, follow the steps below.

Buttons used here

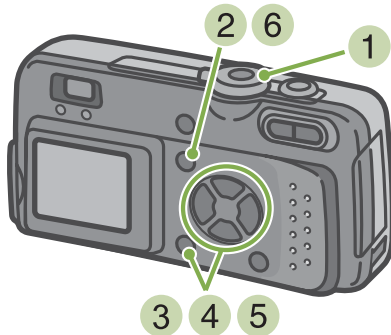

- 1 Turn the Mode Dial to (Shooting Mode).
- 2 Press the **MENU** button.  
The Shooting menu appears.
- 3 Select [EXPOSURE COMP.] and then press the **OK** button.

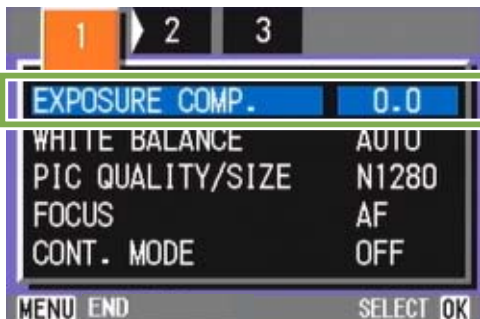

The Exposure Compensation bar appears.

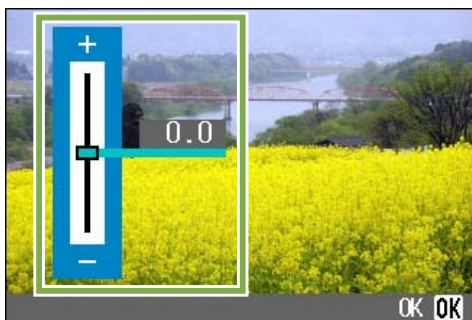

- 4 Press the **▲▼** buttons and specify a value.  
Moving it to the - (minus) side makes darker. Moving it to the + (plus) side makes it brighter.

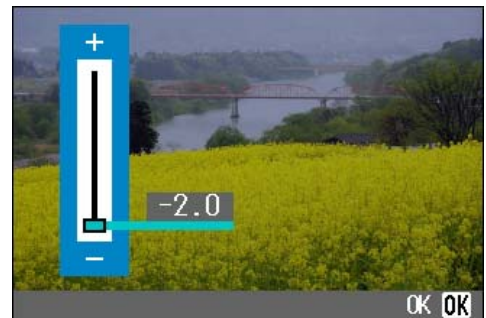
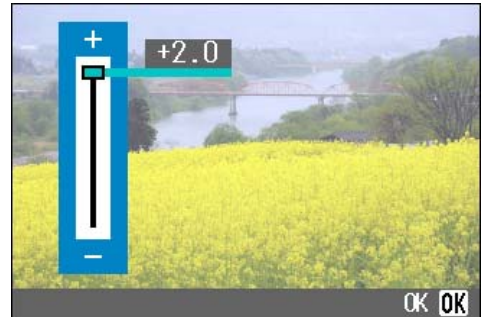

- 5 Press the **OK** button.  
Exposure Compensation settings are completed.
- 6 Press the **MENU** button.  
The Shooting Menu closes and the setting value appears in the right of the screen.



This setting will be used for shooting until you change it.



- At purchase your camera is set to 0.0. When it is set to 0.0, no value is displayed.
- Under backlighting conditions, if the subject is not centered in the shooting range, the camera does not recognize backlighting conditions. Use EXPOSURE COMP.







## Using Natural and Artificial Lighting (WHITE BALANCE)

With a normal camera, a white subject may not be reproduced as white depending on lighting around the subject.

Digital cameras have a function called White Balance, which automatically adjusts white balance so white subjects are reproduced as white. At purchase, the White Balance is set to "AUTO"; normally you do not need to change the setting, but if the camera is having difficulty adjusting, please change the setting.

[Types of Modes you can Select]

Symbol	Mode Name	Description
AUTO	Auto	Make adjustments automatically.
	Daylight	Select when shooting outdoors (Sunny) and White Balance fails to adjust properly.
	Overcast	Select when shooting in cloudy weather or shade and the White Balance fails to adjust properly.
	Tungsten light	Select when shooting under tungsten light and White Balance fails to adjust properly.
	Fluorescent light	Select when shooting under fluorescent light and White Balance fails to adjust properly.
	One Push	Manually set White Balance.



The following subjects may make it difficult for the camera to automatically adjust White Balance:

- Single colored subjects
- Subjects under multiple light sources

To make White Balance settings, follow the steps below.

Buttons used here

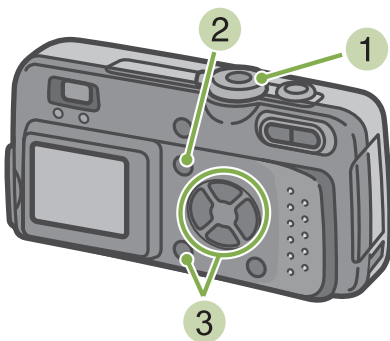

2 Press the **MENU** button.  
The Shooting menu (or the Movie menu) appears.



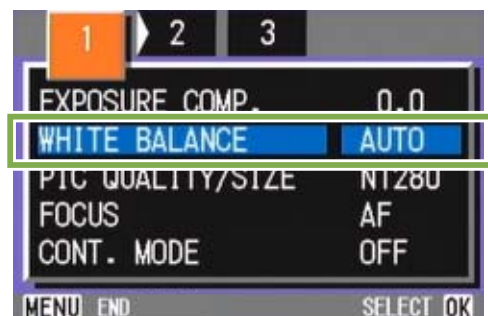

3 Press the **▼** button to select [WHITE BALANCE] and then press the **OK** button.



1 Turn the Mode Dial to  (Shooting Mode).

When shooting in Scene Mode, set to SCENE (Scene Mode) and select Shooting Mode.

When shooting movies, set to  (Movie Mode).

■ If you select AUTO /  /  /  / 

Buttons used here

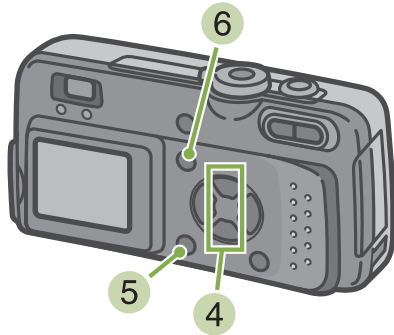

5 Press the **OK** button.  
White Balance settings are complete.

6 Press the **MENU** button.  
The Shooting Menu closes and the setting value is displayed on the upper left of the screen.



This setting will be used for shooting until you change it.

4 Press the **▲ ▼** buttons to select a mode.



- In Auto Mode, if the subject has limited white area, White Balance may not adjust properly. In this kind of situation add a white object to the composition.
- If you have set the camera to Daylight, Overcast, Tungsten or Fluorescent, the flash is set to Flash Off.

■ If you select **M** (One Push)

Buttons used here

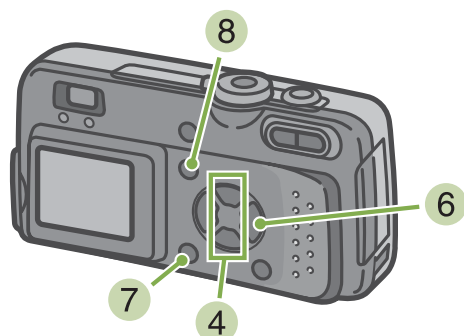

4 Press **▲▼** to select **M** (One Push).

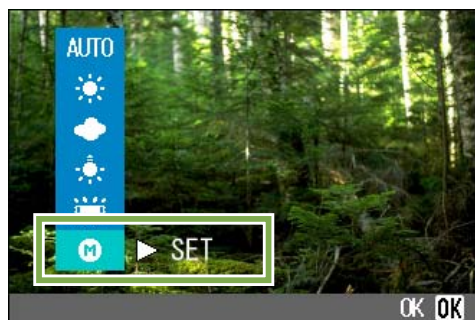

- 5 Point the camera at a piece of paper or something white under the lighting conditions for your picture.
- 6 Press the **▶** button.  
White Balance is set.
- 7 Press the **OK** button.  
White Balance settings are complete.
- 8 Press the **MENU** button.  
The Shooting Menu closes and the setting value is displayed on the upper left of the screen.



This setting will be used for shooting until you change it.



If you press the **▶** button in step **6**, the screen refreshes showing the White Balance settings made. If the result is not as expected, repeat steps **5** and **6** to change the settings as many times as required.

## Choosing Picture Quality Mode/Image Size (PIC QUALITY/SIZE)

The size of stored still image and movie files depends on picture quality and size settings.

### About Picture Quality Mode

When still images and movies are saved as image files, the image data is saved in a compressed file.

Picture Quality Mode specifies the compression ratio to use.

In Picture Quality Mode, there are two types, N(Normal) and F(Fine).

#### Normal Mode

The compression ratio is high, resulting in a small file. Normally, shooting is done in this mode.



#### Fine Mode

The compression ratio is low, resulting in a large file, but the picture quality is better than in Normal Mode.



### About Image Size

Image size relates to how large the image is, and a small image is best for sending via email and using in home pages. When printing pictures, choose the larger size to obtain better results.



#### Saving

Recording data as a file on a medium such as internal memory or SD Memory Card is called "Saving". This is a term generally used in computing when recording on floppy discs or a hard drive.



- Picture quality settings cannot be made for movies.
- Image sizes that can be set differ for still images and movies.



#### Image Files

Files containing still images and movies are called Image Files.

## Changing Picture Quality Mode/ Image Size of a Still Image

Combining Picture Quality Mode and Image Size.

		Size		
		2048×1536	1280×960	640×480
Mode	F(Fine)	<b>F2048</b>	F1280	—
	N(Normal)	N2048	<b>N1280</b>	N640

Figures inside the bold frame indicate those shown on the screen.

/ There is no Fine Mode for 640×480.  
For details, see p.143.

To make changes to Picture Quality Mode/Image Size, follow the steps below.

Buttons used here

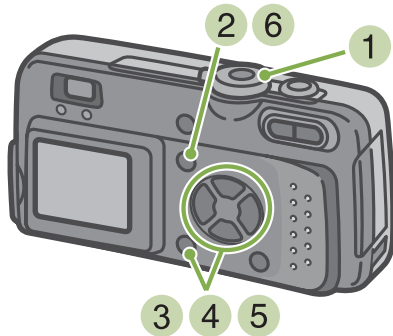

- 3 Select [PIC QUALITY/SIZE] and then press the **OK** button.



- 4 Press the **▲▼** buttons to select [PIC QUALITY/SIZE].



- 5 Press the **OK** button.  
Picture Quality/Image Size settings are completed.
- 6 Press the **MENU** button.  
The Shooting Menu closes and the setting value is displayed on the upper-right of the screen.

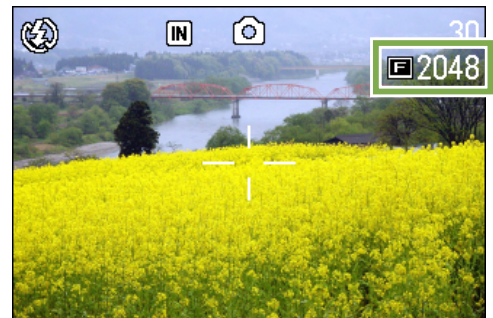

This setting will be used for shooting until you change it.

- 1 Turn the Mode Dial to **📷** (Shooting Mode).  
Alternatively, turn the Mode Dial to **SCENE** (Scene Mode) and select a mode to prepare the camera.
- 2 Press the **MENU** button.  
The Shooting menu appears.



- At purchase your camera is set to N1280.
- In Scene Mode with Text Mode selected, the image size is automatically set to 1280.



## Changing the Image Size of a Movie

Image Quality Mode settings cannot be made for movies.

Two Image sizes are available: 320 × 240, and 260 × 120 pixels.



- At purchase, your camera is set to 320 × 240.

To make changes to Image Size, follow the steps below.

Buttons used here

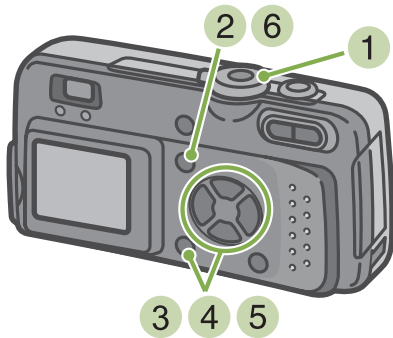

- 1 Turn the Mode Dial to  (Movie Mode).
- 2 Press the **MENU** button.  
The Shooting menu appears.

- 3 Select [MOVIE SIZE] and then press the **OK** button.



- 4 Press the **▲▼** buttons to select Size.

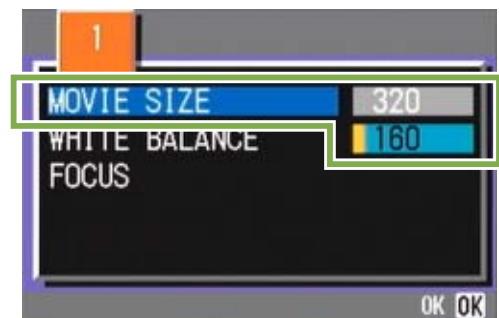

- 5 Press the **OK** button.  
Movie Size settings are complete.
- 6 Press the **MENU** button.  
The Shooting Menu closes and the setting value is displayed on the upper-right of the screen.



This setting will be used for shooting until you change it.

## Manual Focus Shooting (FOCUS)

When Auto-Focus does not focus as desired, you can focus manually (Manual Focus). You can also shoot with a fixed shooting distance. When using a fixed shooting distance, it can be set to either Snapshot or Infinity.

### Manual Focus Shooting

For Manual Focus Shooting, follow the steps below.

Buttons used here

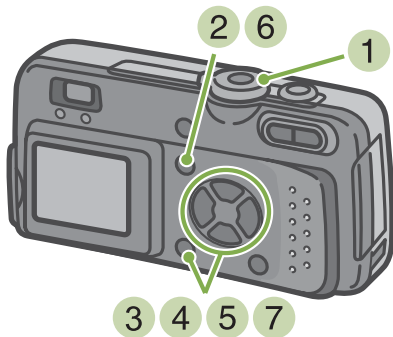

- 1 Turn the Mode Dial to (Shooting Mode).

When shooting movies, set to (Movie Mode).

- 2 Press the **MENU** button.  
The Shooting menu appears.

- 3 Select [FOCUS] and press the **OK** button.



- 4 Press the **▲▼** buttons to select [MF].

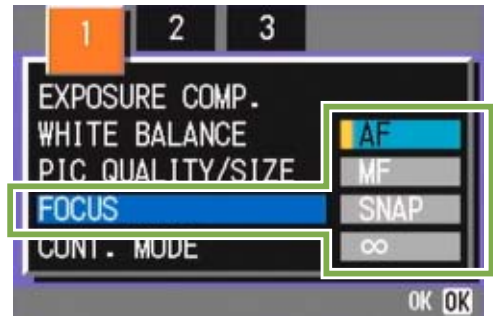

- 5 Press the **OK** button.  
Focus settings are complete.

- 6 Press the **MENU** button.  
The Shooting Menu closes and "MF" is displayed on the upper part of the screen.



- 7 Press the **◀▶** buttons to focus the camera.  
If you press the **◀** button, the focus moves closer.  
If you press the **▶** button, the focus moves further away.

Manual Focus is used for shooting, until you change the settings.



- At purchase your camera is set to AF (Auto-Focus).
- When using Manual Focus, if you press the **OK** button, you can enlarge the central part of the LCD Monitor, which makes it easier to focus. However, it cannot be used for Interval Shooting.
- Manual focus cannot be used in Scene Mode.

## Shooting at a Fixed Shooting Distance

To shoot with the shooting distance fixed, follow the steps below.

Buttons used here

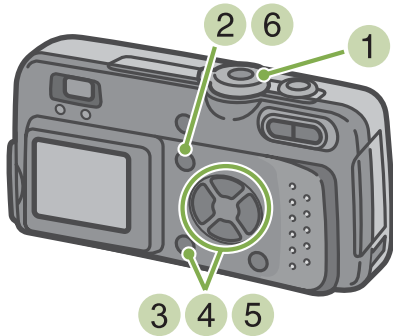

- 1 Turn the Mode Dial to (Shooting Mode).  
When shooting in Scene Mode, set to SCENE (Scene Mode) then select a Shooting Mode.  
When shooting movies, set to (Movie Mode).

- 2 Press the **MENU** button.  
The Shooting menu appears.

- 3 Select [FOCUS] and then press the **OK** button.

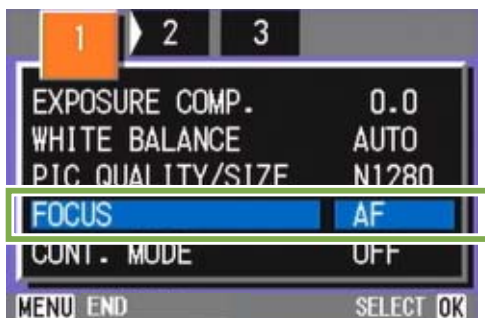

- 4 Press the **▲▼** buttons to select [SNAP] or [∞] (Infinity).

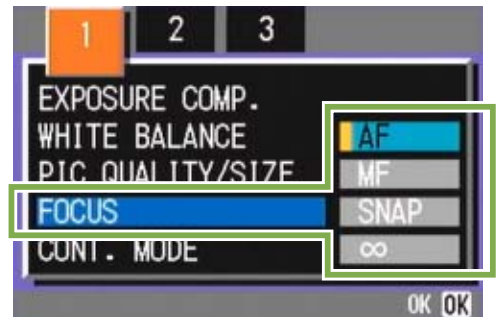

- 5 Press the **OK** button.  
Focus settings are complete.
- 6 Press the **MENU** button.  
The Shooting Menu closes and the specified value is displayed on the upper part of the screen.



This setting will be used for shooting until you change it.



## Changing the Light Metering (PHOTOMETRY)

You can change the metering method (the range to use for metering) to determine the exposure value. There are three Light Metering Methods available: MULTI, CENTRE, and SPOT.

### MULTI

The entire range of the shot is divided into small sections, each of which is measured and the exposure is determined based on the total.

At purchase, your camera is set to this method.



### CENTRE

The light metering is determined by a measurement of the whole, with the central part emphasized.

Use this when the brightness of the center and surroundings are different.



### SPOT

Light metering is determined by measuring only the central part.

Use this setting when you want to use the brightness of the center. It is useful if there is marked difference in contrast or backlighting.



To select light metering method, follow the steps below.

Buttons used here

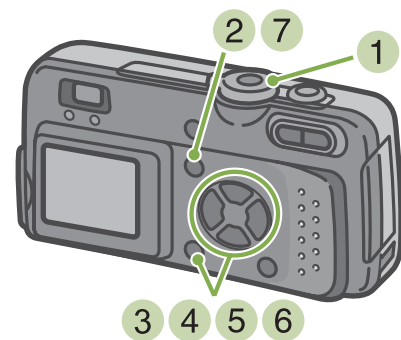

- 1 Turn the Mode Dial to (Shooting Mode).
- 2 Press the **MENU** button.  
The Shooting menu appears.

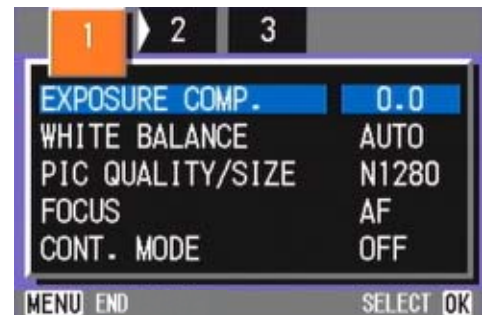

- 3 Press the buttons to switch between displays as required.

- 4 Select [PHOTOMETRY] and then press the **OK** button.



- 5 Press the **▲▼** buttons to select the desired setting.

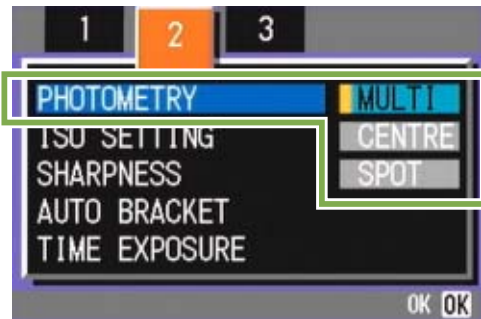

- 6 Press the **OK** button.  
Light Metering Method setting is complete.

- 7 Press the **MENU** button.  
The Shooting Menu closes and the specified value is displayed on the left side of the screen.

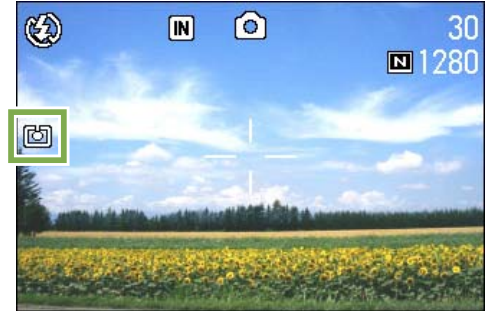

This setting will be used for shooting until you change it.



- At purchase, the setting is Multi.

## Making Sensitivity Settings (ISO SETTING)

You can shoot pictures set to your own sensitivity (ISO SETTING) preference.

At purchase, ISO sensitivity is set to "AUTO". When you want it to be very sensitive, select from among the following three settings: ISO200, ISO400, ISO800.

To set sensitivity, follow the steps below.

Buttons used here

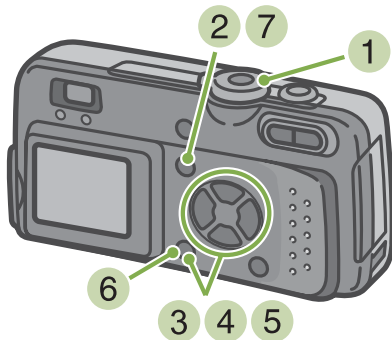

1 Turn the Mode Dial to (Shooting Mode).

2 Press the **MENU** button.  
The Shooting menu appears.

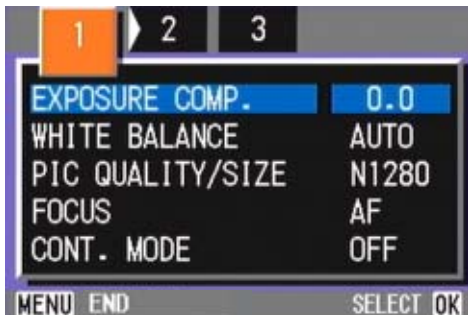

3 Press the **◀▶** buttons to switch between displays as required.

4 Select [ISO SETTING] and then press the **OK** button.



5 Press the **▲▼** buttons to select [ISO SETTING].

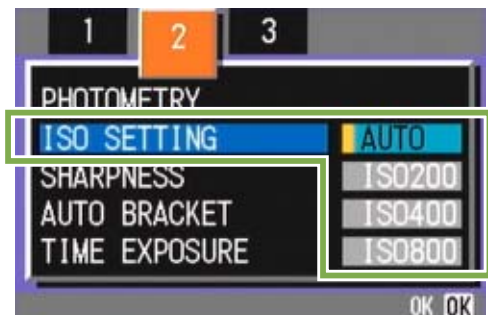

6 Press the **OK** button.  
ISO settings are completed.

7 Press the **MENU** button.  
The Shooting Menu closes and the setting value is displayed on the right of the screen.

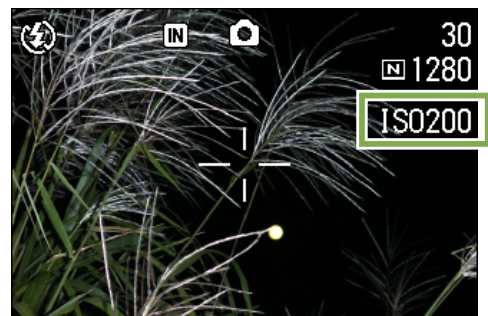

This setting will be used for shooting until you change it.



- At purchase, your camera is set to Auto.
- When shooting in a dark place without using the flash, raising the sensitivity enables you to give a subject more brightness.
- If you raise the ISO Sensitivity, it becomes possible to shoot under low light conditions, but your pictures may become grainy. The higher the ISO Sensitivity, the grainier your pictures are likely to become, so it is necessary to exercise caution.

## Changing the Edge Quality of Still Images (SHARPNESS)

You can change the definition of your still images to either sharp or soft.



At purchase, your camera is set to Normal.

To make changes to the sharpness of still images, follow the steps below.

Buttons used here

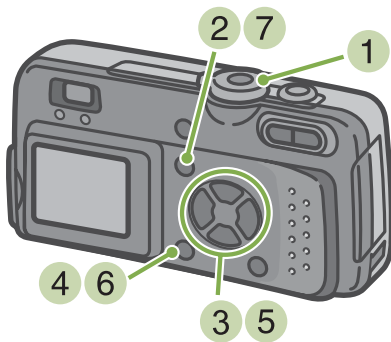

1 Turn the Mode Dial to (Shooting Mode).

2 Press the **MENU** button.  
The Shooting menu appears.

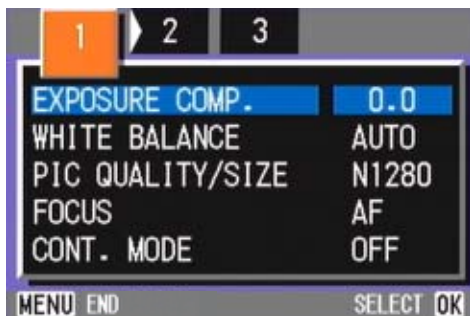

3 Press the **◀▶** buttons to switch between displays as required.

4 Select [SHARPNESS] and then press the **OK** button.



5 Press the **▲▼** buttons to select the desired setting.

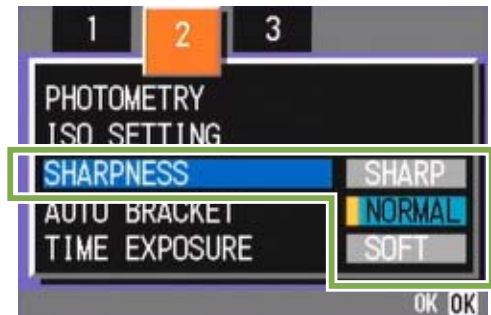

6 Press the **OK** button.  
Sharpness settings are complete.

7 Press the **MENU** button.  
The Shooting Menu closes and the setting value is displayed on the right of the screen.



This setting will be used for shooting until you change it.



## Shooting Consecutively with Different Exposures (AUTO BRACKET)

When shooting in conditions that make exposure settings difficult, using Auto Bracket is helpful. The Auto Bracketing function automatically shoots three consecutive shots, with the specified exposure value as standard, at three exposure levels, at  $-0.5\text{EV}$ ,  $+/-0$ , and  $+0.5\text{EV}$ . You can choose the image that turned out best from among the three shots.



At purchase, your camera is set to OFF.

To shoot with Auto Bracket, follow the steps below.

Buttons used here

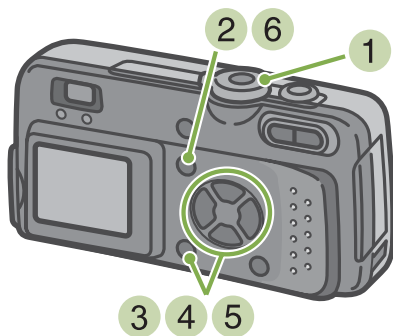

1 Turn the Mode Dial to (Shooting Mode).

2 Press the **MENU** button.  
The Shooting menu appears.

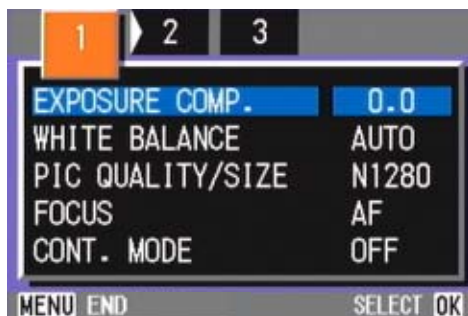

3 Press the **◀▶** buttons to switch between displays as required.

4 Select **[AUTO BRACKET]** and then press the **OK** button.



5 Select **[ON]** and then press the **OK** button.

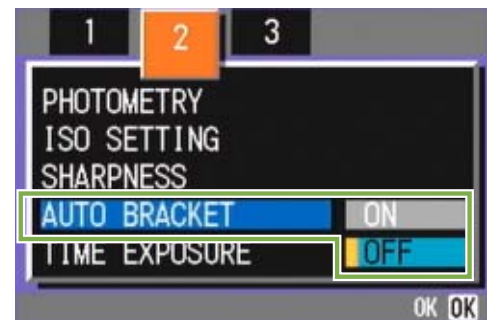

6 Press the **MENU** button.

The Shooting Menu closes and the specified value is displayed on the left side of the screen.



**7** Press the shutter button.

Three consecutive shots are taken, with the specified Exposure Compensation value as the standard, at -0.5EV, +/-0, and +0.5EV.

After shooting, the three shots are displayed on the LCD Monitor. They are from the left, -0.5EV, the standard compensation value, and +0.5EV.



This setting will be used for shooting until you change it.



- For how to change the Exposure Compensation see p.47.
- For how to change the White Balance see p.49.

## Setting the Exposure Time (TIME EXPOSURE)

If you set the camera to TIME EXPOSURE, when you shoot, the shutter stays open for the time specified.

By setting an exposure time, you can capture the track of moving subjects such as fireworks and car lights, when you shoot a night scene. You can select an exposure time of 1, 2, 4 or 8 seconds.



- At purchase, the setting is OFF.
- When the camera is set to Exposure Time, the shutter speed is slowed, so the camera is subject to camera shake. Hold the camera firmly with both hands when you shoot.

Buttons used here

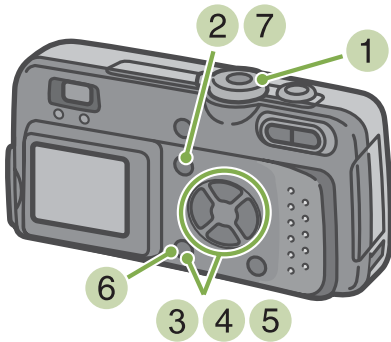

- 4 Select [TIME EXPOSURE] and then press the **OK** button.



- 5 Press the **▲▼** buttons to select Exposure Time.

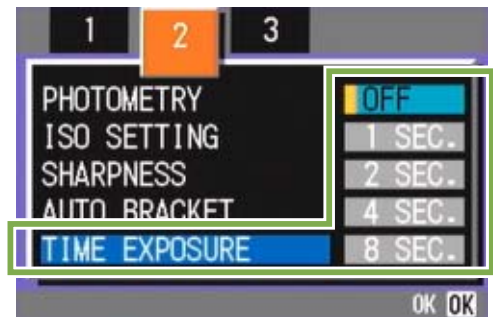

- 1 Turn the Mode Dial to **📷** (Shooting Mode).

- 2 Press the **MENU** button.  
The Shooting menu appears.

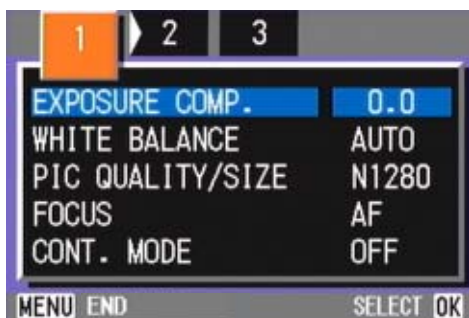

- 3 Press the **◀▶** buttons to switch between displays as required.

- 6 Press the **OK** button.  
Exposure Time settings are completed.

- 7 Press the **MENU** button.  
The Shooting Menu closes and the specified value is displayed on the bottom of the screen.



This setting will be used for shooting until you change it.



## Shooting Pictures Automatically at Set Intervals (INTERVAL)

You can set the camera to automatically take pictures at fixed intervals. The interval between shots can be set from 30 seconds to 3 hours.

For Interval Shooting, follow the steps below.

Buttons used here

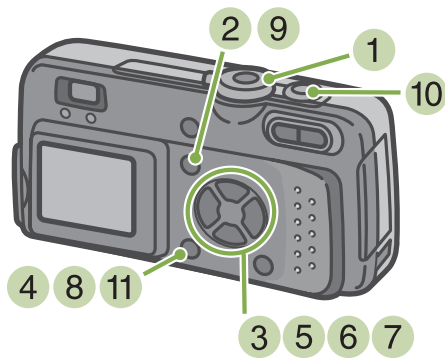

- 4 Select [INTERVAL] and then press the **OK** button.



- 5 Press the **▲▼** buttons to specify the length of time.

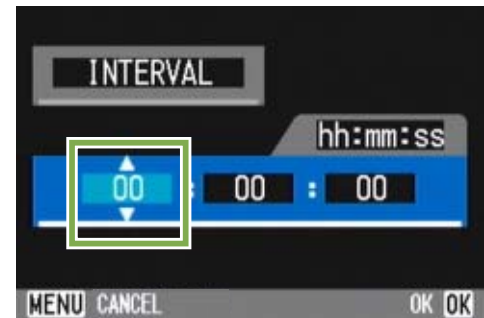

- 1 Turn the Mode Dial to **📷** (Shooting Mode).

- 2 Press the **MENU** button.  
The Shooting menu appears.

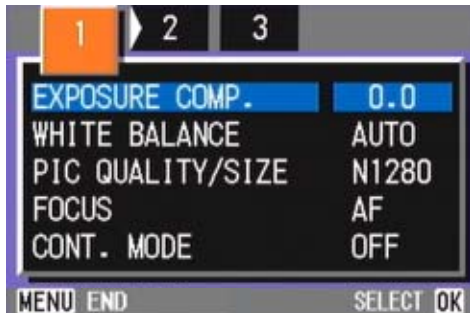

- 3 Press the **◀▶** buttons to switch between displays as required.

- 6 Press the **▶** button to move to the minutes setting, then use the **▲▼** button to set the minutes.

- 7 Press the **▶** button to move to the seconds setting, then press the **▲▼** buttons to set the seconds.

- 8 Press the **OK** button.  
Interval Shooting settings are completed.



When Interval Shooting is on, even when Multi-Shot is set to [CONT], [MCONT], consecutive shooting is automatically switched off.

9 Press the **MENU** button.

The Shooting Menu closes and "Interval" is displayed on the upper part of the screen.



10 Press the shutter button.

A picture is taken every time the fixed interval elapses.

11 To stop shooting, press the **OK** button.

Interval Shooting settings are cleared when the power is turned off.



- In steps 5 to 7, if you press the ▲▼ buttons and hold, you can quickly raise or lower the setting value.
- If you use batteries for power, you may exhaust the batteries. Using the AC Adaptor (sold separately) is recommended.
- Even during Interval Shooting, if you press the shutter button, the camera will shoot as usual. However, Interval Shooting Mode is unaffected. After shooting, once the time specified in Interval Shooting elapses, the next shot is taken.
- Depending on Picture Quality Mode and Flash Mode settings, the shooting interval may become longer than the time set.

## Inserting the Date into a Still Image (DATE IMPRINT)

You can stamp the date on the bottom right of your still images. You can choose to display the date in one of two formats, Date (Y/M/D) or Date and Time (Y/M/D/H:M).

To enter the date or date and time, follow the steps below.

Buttons used here

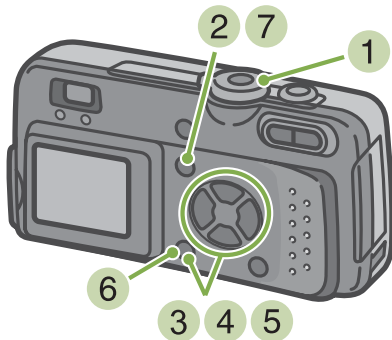

1 Turn the Mode Dial to (Shooting Mode).

2 Press the **MENU** button.  
The Shooting menu appears.

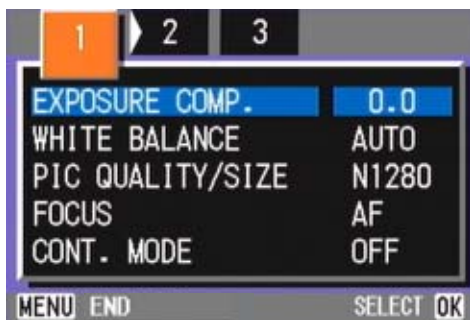

3 Press the **◀▶** buttons to switch between displays as required.

4 Press the **▼** button to select [DATE IMPRINT] and then press the **OK** button.

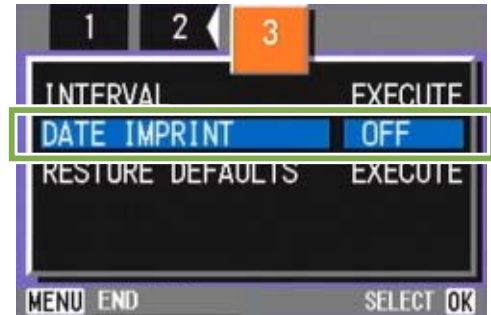

5 Press the **▲▼** buttons to select the desired setting.

6 Press the **OK** button.  
The Date Imprint settings are completed.

7 Press the **MENU** button.

The Shooting Menu closes and **DATE** is displayed on the bottom right of the screen.

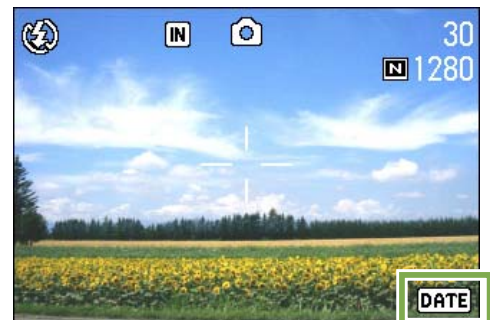

This setting will be used for shooting until you change it.



- If the date and time have not been set, DATE IMPRINT cannot be used. First make the date and time settings.
- DATE IMPRINT cannot be used with movies.
- If you wish to imprint Date Stamp when shooting in TEXT MODE (while in Shooting Mode), make the settings as described above.



For how to set date and time, see p.12.

## Returning the Shooting Menu Settings to their Defaults (RESTORE DEFAULTS)

You can return to the Shooting Menu defaults, as at the time of purchase.

To return the Shooting Menu to its initial settings, follow the steps below.

Buttons used here

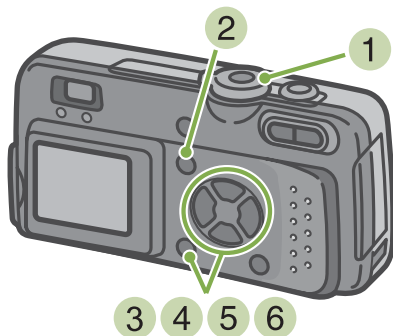

- Press the ◀▶ buttons to switch between displays as required.
- Select [RESTORE DEFAULTS] and then press the **OK** button.

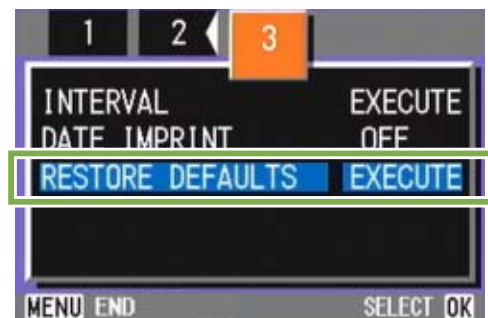

- Press the ▶ button to select [YES].

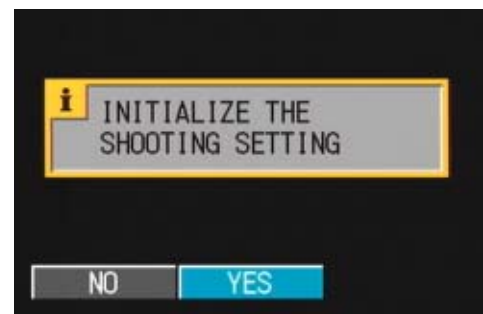

- Turn the Mode Dial to (Shooting Mode).

- Press the **MENU** button.  
The Shooting Menu appears.

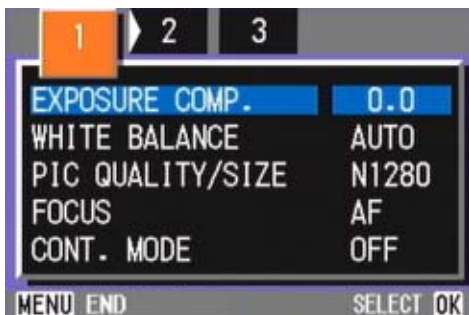

- Press the **OK** button.  
The display indicates the camera is restoring the initial settings; once it is finished, you return to the Mode screen.



RESTORE DEFAULTS are maintained even when the camera is turned off, with the exceptions of Interval Shooting and Auto Bracket settings.

## Displaying the Grid Guide on the LCD Monitor

When you want to shoot an image evenly in the vertical or horizontal direction, it is convenient to display the Grid Guide (calibration scale) and make your composition.

The Grid Guide is made of lines that divide the LCD Monitor screen into thirds both vertically and horizontally. The Grid Guide is displayed only as an aid in shooting and is not part of the picture. With the Grid Guide Display on, symbols (see p.18) will be displayed only for a few seconds right after pressing Self-Timer, Flash or Macro buttons.

To display the Grid Guide, follow the steps below.

- 3 Press the **DISPLAY** button.  
The Grid Guide appears.

Buttons used here

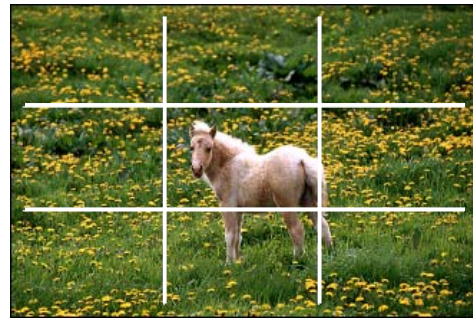
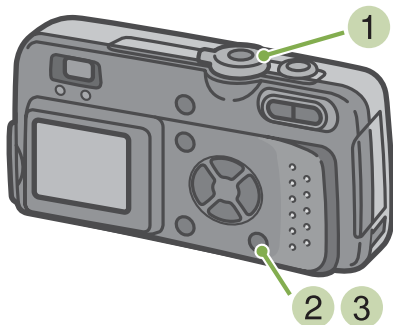

- 1 Turn the Mode Dial to (Shooting Mode).

- 2 Press the **DISPLAY** button.  
The symbol display disappears.



Every time you press the **DISPLAY** button, the view cycles in the sequence of No Display, Grid Guide, LCD Monitor Off, Normal Symbol Display, No Display.



For how to switch the screen display, see p.18.

## Changing Shading for Shooting Text (DENSITY)

When you are shooting text, you can change the DENSITY settings. You can select from DEEP, NORMAL and LIGHT.



For information on how to shoot text, see p.33.

To make changes to the DENSITY, follow the steps below.

Buttons used here

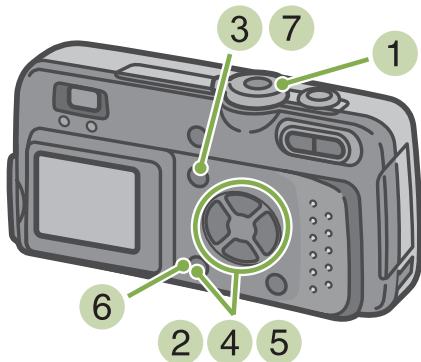

- 1 Turn the Mode Dial to SCENE (Scene Mode).  
The Scene selection screen appears.
- 2 Press the ▲▼ buttons to select the next mode and then press the **OK** button.

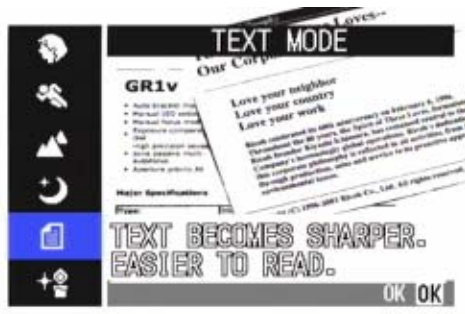

- 3 Press the **MENU** button.  
The Shooting menu appears.

- 4 Select [DENSITY] and then press the **OK** button.



- 5 Press the ▲▼ buttons to select the desired density setting.

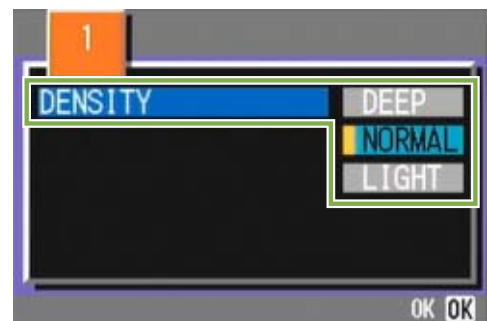

- 6 Press the **OK** button.  
Density settings are complete.
- 7 Press the **MENU** button.  
The display returns to the shooting screen.

This setting will be used for shooting until you change it.



At purchase, your camera is set to Normal.





# Section 4 Viewing Still Images and Movies

---

You can display still images or movies on the LCD Monitor and check them.

This section explains displaying still images and movies on the LCD Monitor.

It is recommended you plug in the AC Adaptor whenever viewing still images or movies on the LCD Monitor.

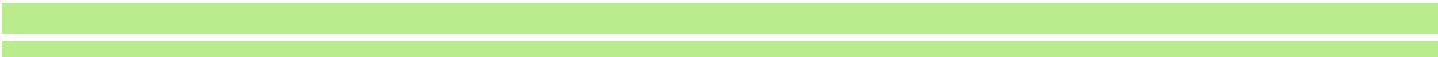

## Viewing the Photo You Just Took

Right after shooting a still image, if you want to see it immediately, you can display the shot in Shooting Mode. This function is called Quick Review.

For movies, the first frame appears as a still image.

To display the still image you just took, follow the steps below.

Buttons used here

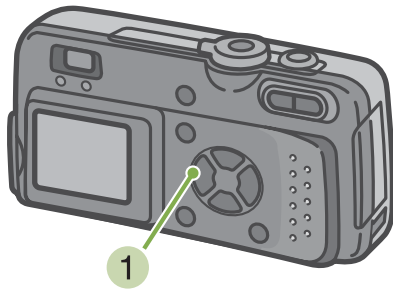



- 1 While still in the Shooting Mode, press the  (Quick Review) button.

The still image you just took is displayed on the LCD Monitor.



Once the power is turned off, Quick Review cannot be displayed again in Shooting Mode.

## Displaying an Enlarged View of the Still Image Displayed

The still image you displayed with the  (Quick Review) button can be displayed enlarged up to 3.4 times using the  (Enlarged View) button.



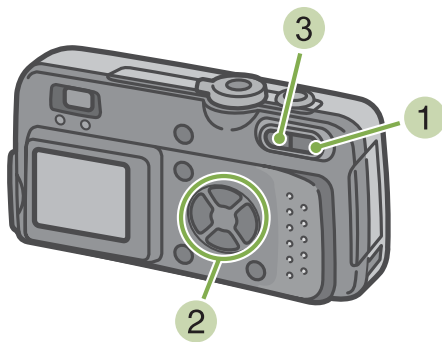

To view still images in the enlarged display mode, follow the steps below.

Buttons used here

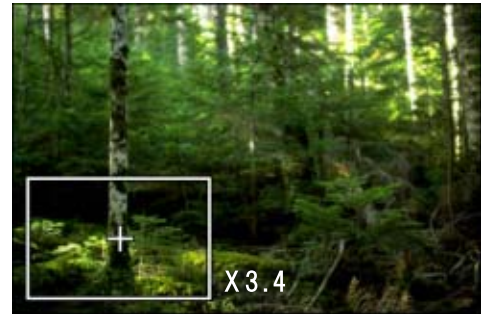

- 1 Press the  (Enlarged View) button.  
The still image is enlarged. One part of the still image is displayed on the LCD Monitor.





- 2 Press the     buttons to move to the part you want to display.
- 3 To return to the original display, press the  (Thumbnail Display) button.



Movies cannot be displayed enlarged.



## Deleting the Displayed Still Image or Movie

The movie or still image you displayed using the  (Quick Review) button can be deleted by pressing the  (DELETE) button.

To delete a still image or movie that is displayed, follow the steps below.

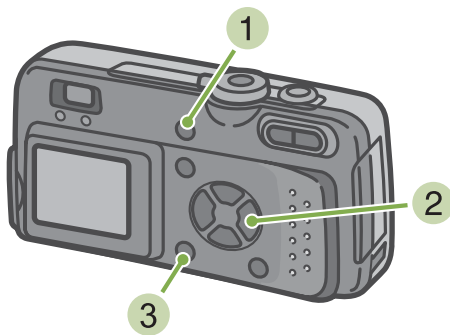
Buttons used here



- 1 While still in Shooting Mode, press the  (Delete) button.
- 2 Press the  button to select [DELETE].

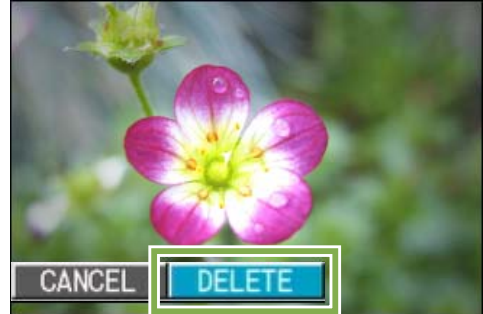

- 3 Press the  button.  
The display indicates that deleting is in process; once finished, you return to the shooting screen.



For selecting and deleting still images and movies, see p.84.

## Viewing a Still Image or Movie

When you take a still image or movie, it is immediately stored in internal memory or on an SD Memory Card. Still images and movies in internal memory or on an SD Memory Card can be displayed on the LCD Monitor.

### Viewing Still Images Recorded on an SD Memory Card

To view still images, follow the steps below.

Buttons used here

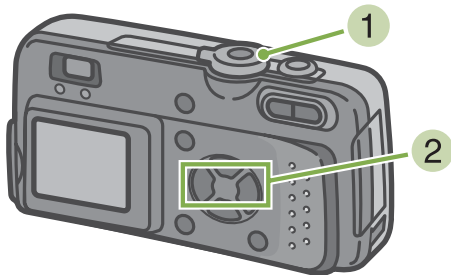

- 1 Turn the Mode Dial to (Playback Mode). The last still image taken is displayed.

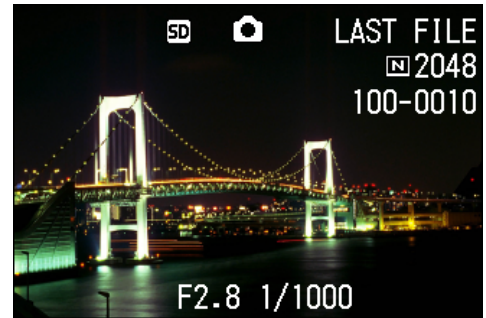

For movies, the first frame is displayed as a still image.

- 2 Move to the still image you want to view using the buttons.
  - If you press the button, you can view the next still image or movie.
  - If you press the button, you can view the previous still image or movie.
  - If you press and hold the buttons, you can move quickly between images.



For information displayed on the screen during playback, see p.17



• Images are played back from the following recording media:

When no memory card is loaded









When an SD Memory Card is loaded



## Viewing Still Images Recorded on Internal Memory

To view still images recorded on internal memory, follow the steps below.

- 1 If an SD Memory Card is loaded, turn off the power, remove the SD Memory Card and turn the power back on.
- 2 Turn the Mode Dial to  (Playback Mode).  
The last still image taken is displayed.  
For movies, the first frame is displayed as a still image.
- 3 Move to the still image you want to view using the   buttons.  
If you press the  button, you can view the next still image or movie.  
If you press the  button, you can view the previous still image or movie.  
If you press and hold the   buttons, you can move quickly between images.



## Viewing Movies

To view photos, follow the steps below.

### Buttons used here

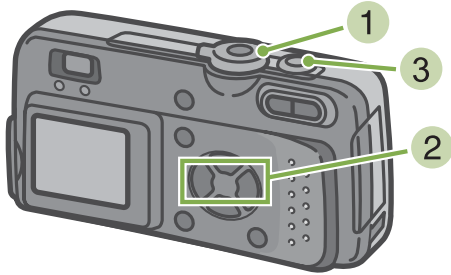

### 3 Press the shutter button.

Playback begins. The elapsed playback indicator or the elapsed time is displayed on the LCD Monitor.



Fast Forward	Press the [Z] (telephoto) button during play.
Rewind	Press the [W] (Wide-Angle) button during play.
Pause/Playback	Press the shutter button.
Slow Playback	Go on pressing the [Z] (telephoto) button during pause.
Slow Rewind	Go on pressing the [W] (Wide-Angle) button during pause.
Next frame	Press the [Z] (telephoto) button during pause.

### 1 Turn the Mode Dial to [M] (Playback Mode).

The last still image taken is displayed.

For movies, the first frame is displayed as a still image.

### 2 Move to the movie you want to see using the [L] [R] buttons.

If you press the [R] button, you can view the next still image or movie.

If you press the [L] button, you can view the previous still image or movie.



### Movie Frames

Movies are made up of many frames which seem to move when displayed at high speed.



For information displayed on the screen during playback, see p.17.

## Viewing at a Glance

The LCD Monitor screen is split into 6, allowing you to view your still images or movies at one glance (Thumbnail Display). If you select a still image or movie you want to see from Thumbnail Display Mode, you can view it normally with just the one shot displayed.

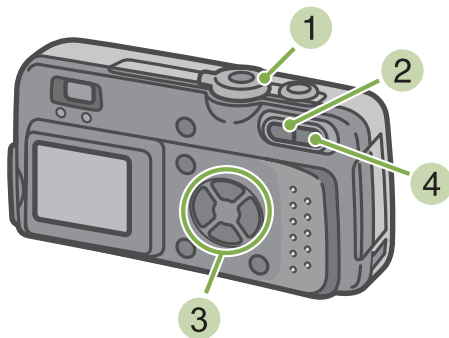

To view the Thumbnail Display and select the still image for viewing, follow the steps below.

### Buttons used here

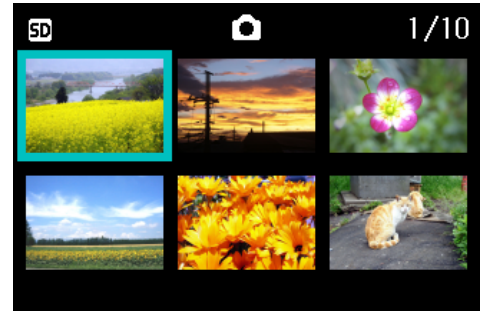

- 2 Press the  (Thumbnail Display) button. The screen is split into six sections. Still images and movies (the first frame) are displayed in a reduced size.



- 3 Press the  buttons to select the still image or movie you want to display.
- 4 Press the  (Enlarged View) button. The still image or movie you selected is displayed.

- 1 Turn the Mode Dial to  (Playback Mode). The last still image taken is displayed.



For movies, the first frame is displayed as a still image.



In Thumbnail Display mode, text files are displayed in blue.



For how to select and delete still images and movies in the Thumbnail Display screen, see p.84.  
For how to select and protect (protect from deleting) still images and movies in the Thumbnail Display screen, see p.88.  
For how to select still images and movies and make Print Service settings in the Thumbnail Display screen, see p.92.



### Thumbnail Display

A thumbnail display is a reduced display. This is a method commonly used for displaying many images at a glance.

## Enlarged Viewing

When you are displaying a still image, if you press the  (Enlarged View) button, you can display the still image up to 3.4 times larger.

To view still images in Enlarged Display Mode, follow the steps below.

Buttons used here

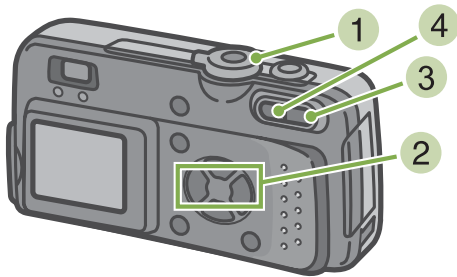





- 1 Turn the Mode Dial to  (Playback Mode).  
The last still image taken is displayed.

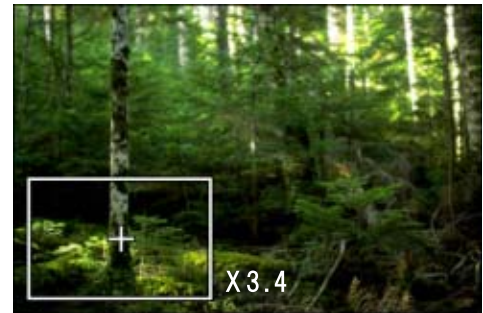

- 2 Display the still image you want to enlarge.
- 3 Press the  (Enlarged View) button.  
The still image is enlarged. One part of the still image is displayed on the LCD Monitor.



Press the     buttons to move to the part you want to display.

- 4 To return to the original display, press the  (Thumbnail Display) button.



Movies cannot be displayed enlarged.



For how to display still images, see p.71 and p.74.

## Showing Photos in Order Automatically (SLIDE SHOW)

You can show still images or movies recorded in internal memory or on an SD Memory Card sequentially on the LCD Monitor. This function is called a slideshow.

To view a slideshow, follow the steps below.

Buttons used here

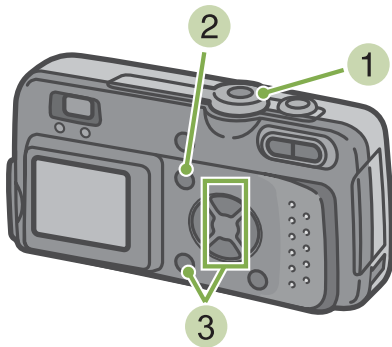

- 3 Confirm you are selecting [SLIDE SHOW] and then press the **OK** button.



The slideshow starts and the still images or movie frames are shown in order.

If you want to stop the slideshow in progress, press any button on the camera.

Until stopped, the slideshow will repeat itself.

- 1 Turn the Mode Dial to (Playback Mode).  
The last still image taken is displayed.



- 2 Press the **MENU** button.  
The Playback menu is displayed.



- Still images are displayed for 3 seconds each.
- For movies, not just one frame, but the entire movie you shot is displayed.

## Viewing on a Television

You can also view the still images and movies you have taken on a TV screen. The camera displays everything on the TV screen just as on its LCD Monitor.

To use your television for viewing, connect your camera to the television with the video cable that came with your camera.

To view still images and/or movies on a television, follow the steps below.

Buttons used here

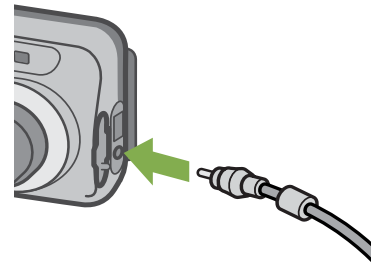
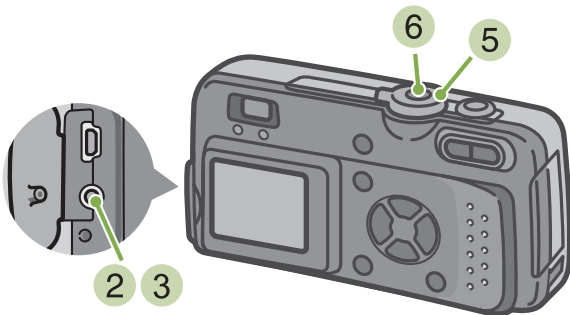

- 1 Securely connect the video cable to the Video In terminal on the television.

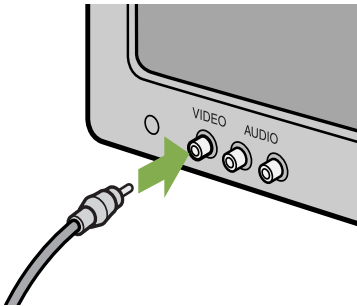

- 2 Make sure the camera's power is off, and then open its terminal cover.
- 3 Securely connect the video cable to the Video Out terminal.

- 4 Set the television to "Video" mode. (Set the input to "Video".)  
For details, refer to the television's manual.
- 5 Turn the camera's Mode Dial to  (Playback Mode).
- 6 Turn your camera on by pressing the power button.



- If you connect the video cable to your video recorder's In terminal, you can record what you have shot onto video.
- Your camera is set to NTSC playback format (used in Japan and other countries) for use with television equipment, etc. If the equipment you want to connect to uses PAL format (used in Europe and elsewhere), then switch your camera to PAL format in the Setup Menu before connecting.
- When the video cable is connected to the camera, the LCD Monitor display will go off.



# Section 5 Deleting Still Images and Movies

---

One of the big advantages of digital cameras is that you can delete unwanted still images and movies on the spot. This section explains deleting still images and movies you have taken.



For how to prevent still images from accidental deleting, see p.85.

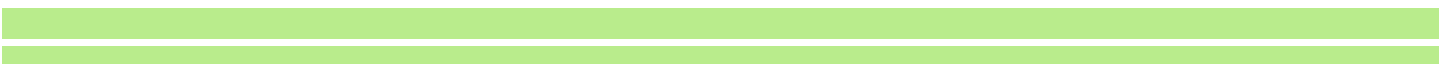



## Deleting Unwanted Still Images or Movies

You can easily delete still images and movies that have not come out right. The following are the three ways to delete photos:

- One shot at a time
  - All frames at once
  - Select multiple frames and delete together
- Still images and movies set to Protect cannot be deleted.



Still images or movies recorded on the following media are deleted.  
When no memory card is loaded



Deletes from  
internal memory

When an SD Memory Card is loaded

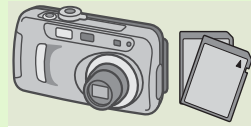

Deletes from SD  
Memory Card

### Deleting One Still Image

To delete a still image (or movie), follow the steps below.

Buttons used here

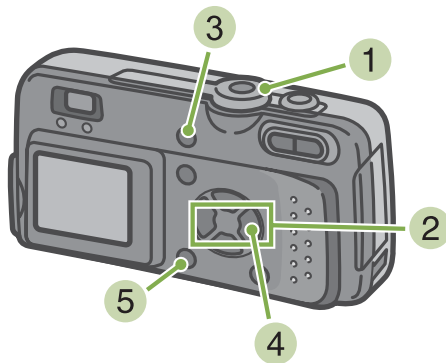

- 1 Turn the Mode Dial to (Playback Mode).  
The last still image taken is displayed.



- 2 Display the still image (or movie) you want to delete.
- 3 Press the (Delete) button.
- 4 Press the button to select [DELETE ONE].



- 5 Press the button.  
The display indicates deleting is in process; once finished, you return to the playback screen.



- For how to delete a still image displayed with the (Quick Review) button, see p.73.
- For how to display still images (or movies), see p.71 and p.74.

## Deleting All Frames at Once

To delete all still images or movies, follow the steps below.

Buttons used here

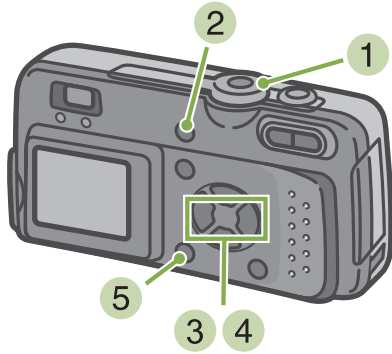

- 1 Turn the Mode Dial to (Playback Mode).  
The last still image taken is displayed.

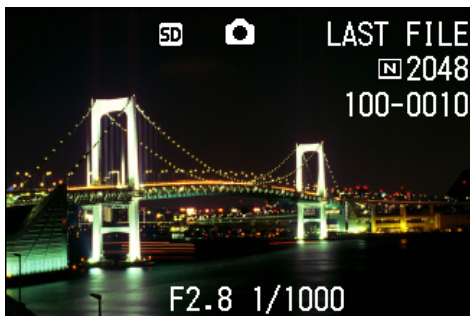

- 2 Press the (Delete) button.
- 3 Press the button to select [DELETE ALL] and press the **OK** button.  
A screen appears to confirm deleting.



- 4 Press the button to select [YES].

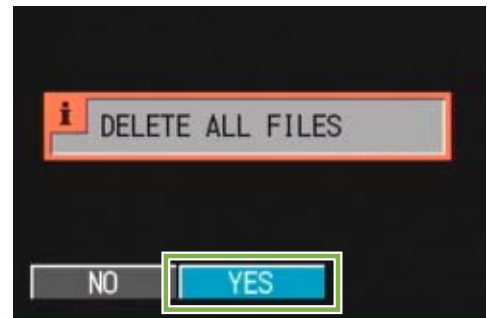

- 5 Press the **OK** button.  
The display indicates deleting is in process; once finished, you return to the playback screen.



- For how to display still images (or movies), see p.71 and p.74.
- For how to protect still images (or movies), see p.85.

## Deleting Multiple Frames at Once

To delete selected still images or movies all at once, follow the steps below.

### Buttons used here

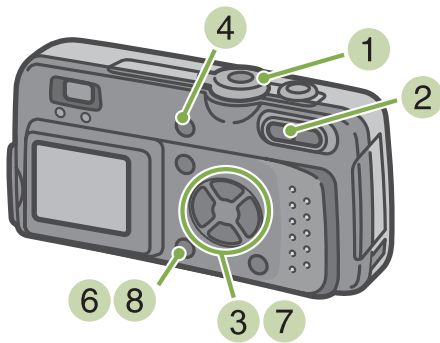

- 1 Turn the Mode Dial to (Playback Mode).  
The last still image taken is displayed.



- 2 Press the (Thumbnail Display) button.  
The screen is split into six sections. Still images and movies (the first frame) are displayed in a reduced size.

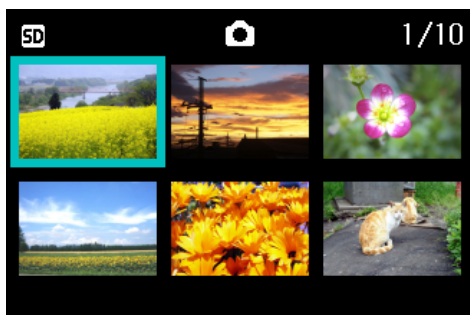

- 3 Press the buttons to select the still images or movies you want to delete.
- 4 Press the (Delete) button.  
The trash symbol appears in the upper left of the still image (or movie).



- 5 Repeat Steps 3 and 4 to select all the still images you wish to delete.  
If you selected an image by mistake, you can deselect it by selecting the image and pressing the (Delete) button again.
- 6 Press the button.  
A screen appears to confirm deleting.

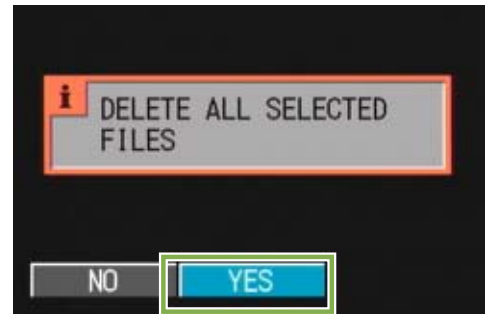

- 7 Press the button to select [YES].
- 8 Press the button.  
The display indicates deleting is in process; once finished, you return to the Thumbnail Display screen.



For details on thumbnail display, see p.77.

## Write-protecting Your Images (PROTECT)

You can protect still images and movies from being accidentally deleted. There are 3 methods of making Protect settings:

- One shot at a time
- All frames at once
- Select multiple frames and protect together

Still images and movies that are protected cannot be deleted. However, when formatting is executed, it makes no difference whether files are protected or not: all are deleted.

### Protecting the Displayed Still Image

To protect a still image (or movie), follow the steps below.

Buttons used here

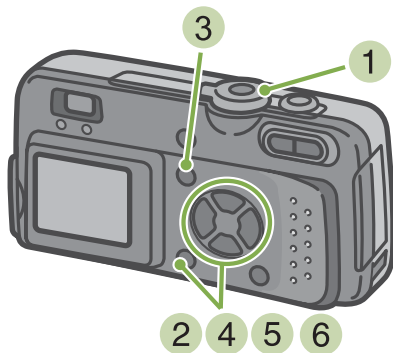

- 1 Turn the Mode Dial to (Playback Mode).  
The last still image taken is displayed.

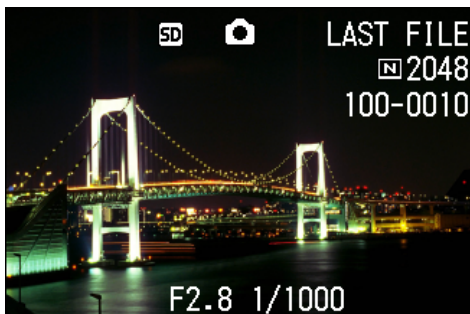

- 2 Display the still image (or movie) you want to protect.
- 3 Press the **MENU** button.  
The Playback menu is displayed.
- 4 Press button to select [PROTECT] and then press the **OK** button.



- 5 Press the button to select [1 FILE].



6 Press the **OK** button.

When set to Protect, the Protect symbol appears in the upper left of the screen.

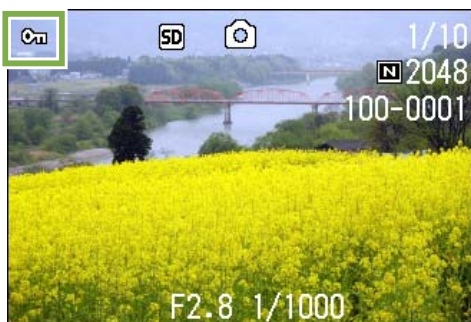

The procedure for releasing protection from one file at a time is the same as that for setting protection.



- For how to display still images (or movies), see p.71.
- To remove protection of all still images (or movies) at once, see p.87.
- To remove protection of selections made on the Thumbnail Display screen, see p.88.



## Protecting All Still Images

To protect all your still images (or movies), follow the steps below.

Buttons used here

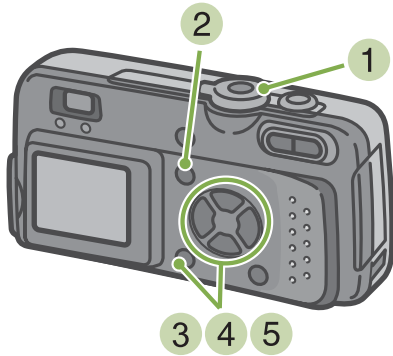

- 1 Turn the Mode Dial to (Playback Mode).
- 2 Press the **MENU** button.  
The Playback menu is displayed.
- 3 Press the button to select [PROTECT] and then press the **OK** button.



- 4 Press the button to select [ALL FILES].



- 5 Confirm you are choosing [SELECT] and then press **OK** .  
When set to Protect, the Protect symbol appears in the upper left of the screen.

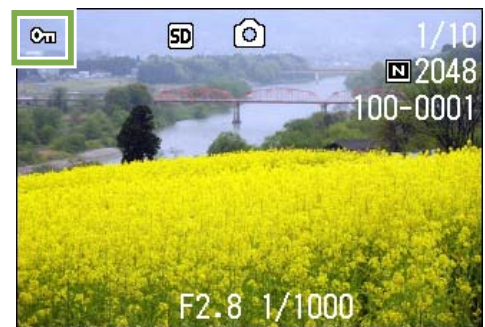

- To remove protection from all your still images (or movies), select [RELEASE] in step **5**.
- You can remove protection from all or multiple images (or movies) at once.



- To remove protection for one still image at a time, see p.85.
- To remove protection of selections made on the Thumbnail Display screen, see p.88.



## Protecting Multiple Still Images or Movies at Once

To protect selected still images or movies all at once, follow the steps below.

Buttons used here

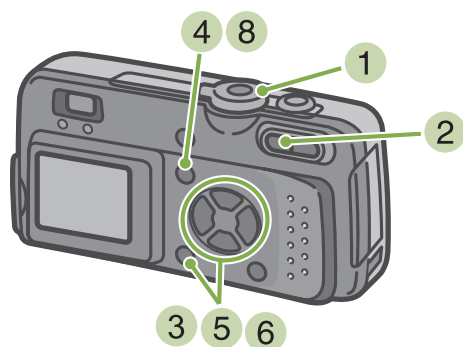

- 1 Turn the Mode Dial to (Playback Mode).
- 2 Press the (Thumbnail Display) button.  
The screen is split into six sections. Still images and movies (the first frame) are displayed in a reduced size.
- 3 Press the buttons to select the still image or movie you want to display.
- 4 Press the **MENU** button.  
The Playback menu appears.

- 5 Press the button to select [PROTECT] and then press the **OK** button.  
The Protect symbol appears in the upper left of the first still image (or movie).



- 6 Press the buttons to select the still image or movie you wish to Protect and press the **OK** button.  
The Protect symbol appears in the upper left of the still image (or movie).

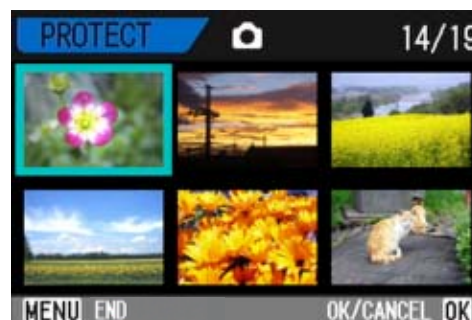

- 7 Repeat Step 6 to select all the still images or movies you wish to protect.  
If you selected an image by mistake, you can deselect by selecting the image and pressing the **OK** button again.
- 8 Press the **MENU** button.



To remove protection from multiple still images (or movies), following the steps described above, select the still images or movies you wish to release and implement.



- For details on thumbnail display, see p.77.
- To remove protection for one still image at a time, see p.85.
- To remove all protection at once, see p.87.



## Copying the Contents of Internal Memory to a Memory Card (COPY TO CARD)

You can copy all the movie and still image data stored in internal memory onto an SD Memory Card at once.

To copy still images and movies from internal memory to SD Memory Card, follow the steps below.

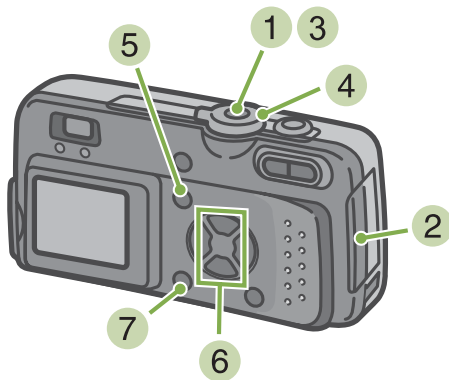
Buttons used here



- 3 Turn the camera on.
- 4 Turn the Mode Dial to  (Playback Mode).
- 5 Press the **MENU** button.  
The Playback menu appears.
- 6 Press the  button to select [COPY TO CARD].



- 1 Turn your camera off by pressing the power button.
- 2 Insert the SD Memory Card.
- 7 Press the **OK** button.  
The display indicates copying is in process; once finished, you return to the playback screen.



- If the capacity of the SD Memory Card you are copying to is insufficient, a message will be displayed indicating there is not enough capacity. To copy only the number of shots that will fit into the available capacity, select [YES] and then press the [OK] button. To cancel copying, select [NO] and then press the [OK] button.
- It is not possible to copy from SD Memory Card to internal memory.

## Using a Printing Service (PRINT)

The still images recorded on SD Memory Card can be printed out if you take them to a shop that offers a digital camera print service. To use a print service, it is necessary to make settings required for printing. These settings are called DPOF (Dee-Pof) settings.

There are 3 methods of making DPOF settings:

- Set one shot at a time
- Set for All Still Images
- Select multiple shots and set together

### Setting DPOF for the Still Image Displayed

To make DPOF settings for one still image, follow the steps below.

Buttons used here

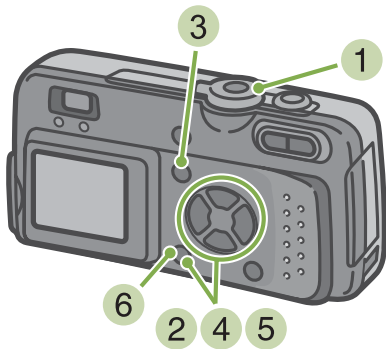

- 5 Press the **▶** button to select [1 FILE].



- 6 Press the **OK** button.  
Once the DPOF setting is made, the DPOF symbol appears in the upper left of the screen.

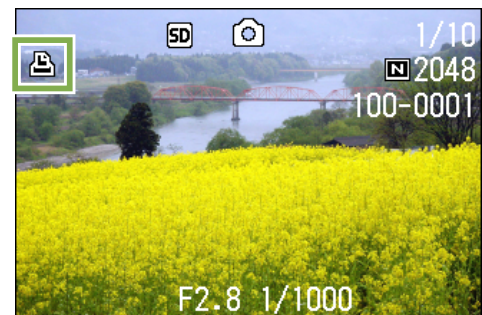

- 1 Turn the Mode Dial to **▶** (Playback Mode).
- 2 Display the still image you want to specify.
- 3 Press the **MENU** button.  
The Playback menu is displayed.
- 4 Press **▼** button to select [PRINT] and then press the **OK** button.



- Removing the DPOF setting for one photo at a time is done in the same way as setting it.
- You can specify one print per still image with this function.



- To display a still image, see p.71 and p.74.
- For how to release all DPOF settings at once, see p.91.

## Setting DPOF for All Still Images

To make DPOF settings for all your still images, follow the steps below.

Buttons used here

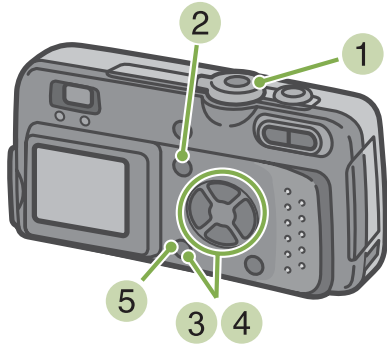

- 1 Turn the Mode Dial to (Playback Mode).
- 2 Press the **MENU** button.  
The Playback menu appears.
- 3 Press **▼** button to select [PRINT] and press the **OK** button.



- 4 Press the **▶** button to select [ALL FILES].



- 5 Confirm you are choosing [SELECT] and then press **OK**.

Once the DPOF setting is made, the DPOF symbol appears in the upper left of the screen.

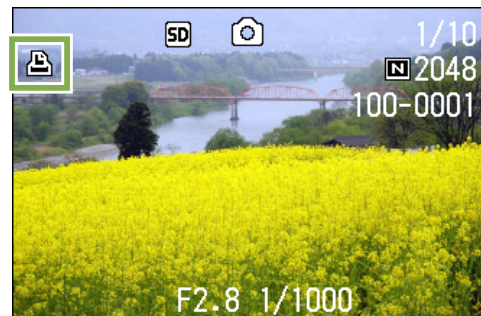

- To remove the DPOF setting from all your still images, select [RELEASE] in step **5**.
- You can remove all or multiple still image DPOF settings at once.



- To remove the DPOF setting for 1 still image at a time, see p.90.
- To remove the DPOF settings of selections made on the Thumbnail Display screen, see p.92.

## Setting DPOF for Multiple Still Images

To make the DPOF setting for selected still images all at once, follow the steps below.

### Buttons used here

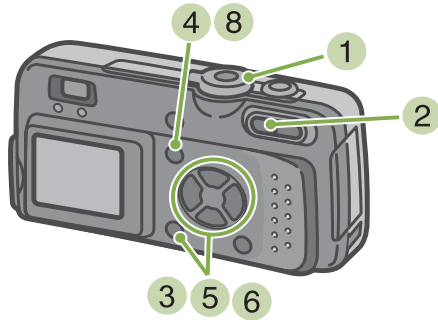

- 1 Turn the Mode Dial to (Playback Mode).
- 2 Press the (Thumbnail Display) button.  
The screen is split into 6 sections with the still images displayed at a reduced size.
- 3 Press the buttons to select the first still image for which you wish to make the DPOF setting.

- 4 Press the **MENU** button.  
The Playback menu appears.
- 5 Press the button to select [PRINT] and then press the **OK** button.  
The DPOF symbol appears in the upper left of the first still image.
- 6 Press the buttons to select the next still image you wish to set to DPOF, and then press the **OK** button.  
The DPOF symbol appears in the upper left of the still image.

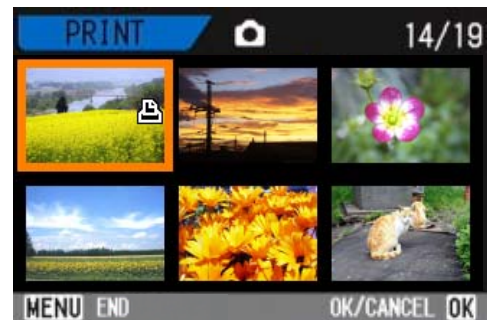

- 7 Repeat Step 6 to select all the still images for which you wish to make the DPOF setting.  
If you selected an image by mistake, you can deselect it by selecting the image and pressing the **OK** button again.
- 8 Press the **MENU** button.  
The display returns to the Thumbnail Display screen.



# Section 6 Changing Camera Settings

---

This section explains how to make changes to the camera's settings.



In this section, still images and movies will both be referred to as "Images".

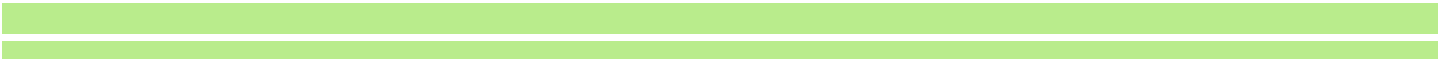



## Getting the SD Memory Card Ready for Use (CARD FORMAT)

If an error message "This card cannot be used." is displayed, or if you have formatted a card with a computer or some other device, it is necessary to format the SD Memory Card prior to use.



For how to format internal memory, see p.95.

To format, follow the steps below.

Buttons used here

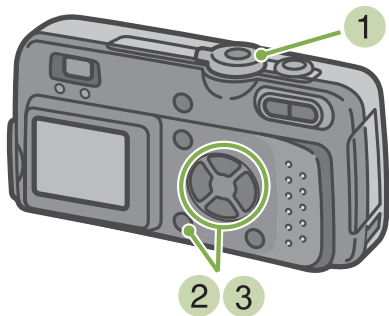

- 1 Turn the Mode Dial to SETUP (Setup Mode). The Setup Screen appears.
- 2 Select [CARD FORMAT] and then press the **OK** button.

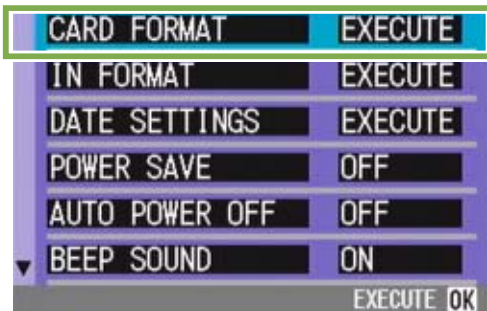

A screen appears to confirm formatting.

- 3 Press the **▶** button to select [YES] and then press the **OK** button.

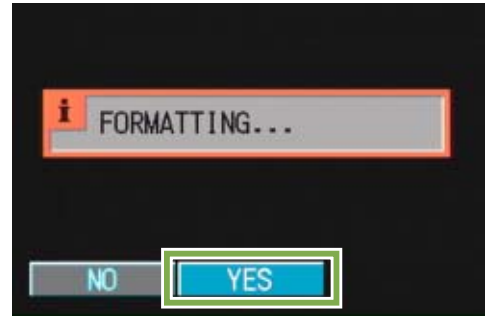

Formatting commences. When it finishes the SETUP screen returns.

If an SD Memory Card is not loaded, a message will be displayed. After turning the power off, load an SD Memory Card and repeat the formatting process again.

### Write-protecting your images

If you move the card's write-protection switch to LOCK, your still images cannot be accidentally erased and the memory card cannot be formatted. If you return the switch to the former position, it is once again possible to erase images and format the card.



If you format a card that still has images stored on it, these will be lost.



#### Formatting

Formatting is the process of preparing a card so image data can be written on it. This is also called initialization. In general, this term is commonly used when a floppy disc or other media is prepared for saving.

## Formatting Internal Memory (IN FORMAT)

To format, follow the steps below.

Buttons used here

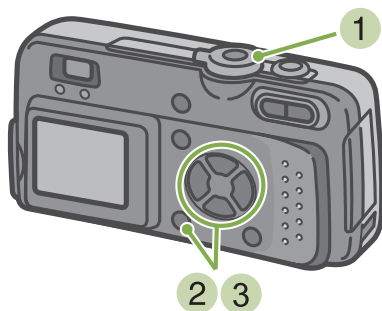

- Press the **▶** button to select [YES] and press the **OK** button.

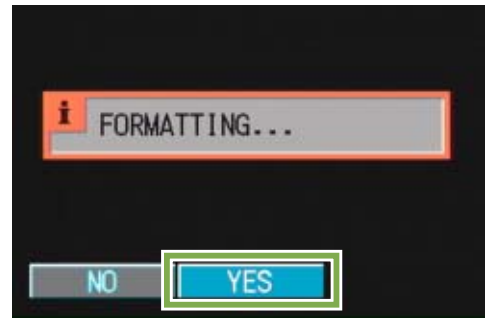

Formatting commences. When it finishes, the SETUP screen returns.

- Turn the Mode Dial to **SETUP** (Setup Mode). The Setup Screen appears.
- Select **[IN FORMAT]** and then press the **OK** button.

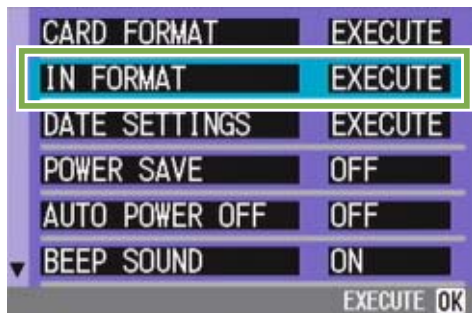

A screen appears to confirm formatting.

## Changing Power-Save Mode Settings (POWER SAVE)

You can reduce the power consumption of the LCD Monitor and extend the life of your batteries. At the time of purchase, Power-Save Mode is set to [OFF].

### Possible Settings

OFF (Power Save Mode Inactivated) / Set at purchase  
ON (Activate Power Save Mode)

To change the Power-Save Mode, follow the steps below.

- 1 Turn the Mode Dial to SETUP (Setup Mode).  
The Setup Screen appears.

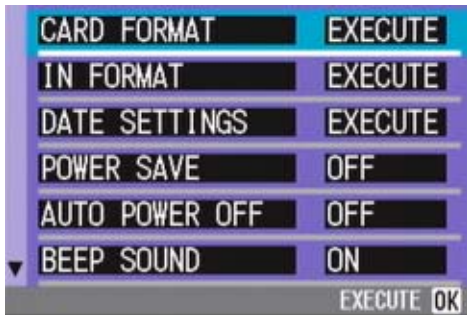

- 2 Press the ▼ button to select [POWER SAVE].

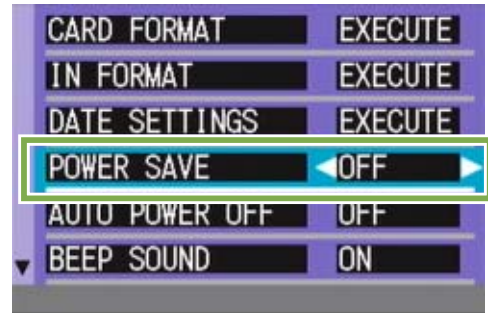





- 3 Press ◀▶ to select the desired setting.

This setting will be used until you change it.



If you have activated Power Save mode, power consumption will be less, but there are the following limitations.

- The display on the LCD Monitor will turn off. Press the  (Quick Review) button or the **MENU** button to turn the LCD Monitor Display on, and then press them again to turn the display off. You cannot turn the LCD Monitor Display on/off by pressing the ,  (Flash) or  (Macro) buttons. Processing time may be slower.
- It works only in Shooting Mode. It does not work in Playback Mode.

## Changing Auto Power-Off Settings (AUTO POWER OFF)

If you do not operate the camera for the set period of time, it will shut off automatically (Auto Power-off) to conserve battery power.

At the time of purchase, Auto Power-Off is set to one minute, but you can change this setting.

### Possible Settings

OFF (The Auto Power-Off function does not work)  
 1 Minute / Set at purchase  
 5 Minutes  
 30 Minutes

To change the Auto Power-Off setting, follow the steps below.

- 1 Turn the Mode Dial to SETUP (Setup Mode).  
The Setup Screen appears.

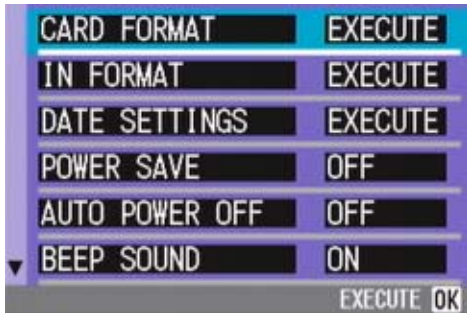

- 2 Press the ▼ button to select [AUTO POWER OFF].

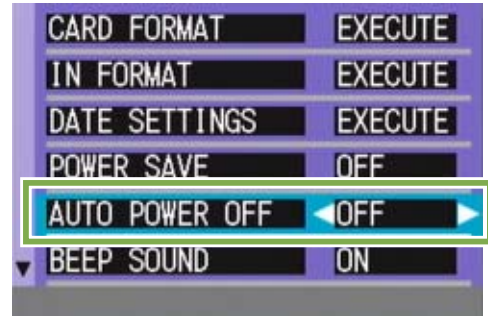

- 3 Press the ◀▶ buttons to select the desired setting.

This setting will be used until you change it.



- When Auto Power-Off turns off the camera, just press the power button again to turn it on and resume use.
- The Auto Power-off function does not work when connected to a computer.
- When shooting with Interval Shooting, settings made here are not valid and Auto Power-Off does not work.

## Buzz at Recording (BEEP SOUND)

When you shoot an image, it is immediately recorded to internal memory or SD Memory Card. When recording, your camera makes a beep sound to let you know it is recording.

You can set the camera so it does not make this sound.

### Possible Settings

ON (Make sound) / Set at purchase  
OFF (Silent)

To make changes to the beep sound, follow the steps below.

- 1 Turn the Mode Dial to SETUP (Setup Mode).  
The Setup Screen appears.

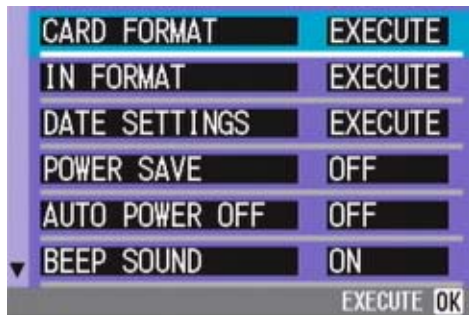

- 2 Press the ▼ button to select [BEEP SOUND].

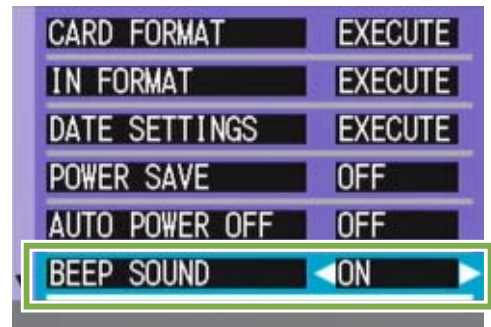

- 3 Press the ◀▶ buttons to select the desired setting.

This setting will be used until you change it.

## Changing File Name Settings (SEQUENTIAL NO.)

When you shoot a still image, it is stored on SD Memory Card or in internal memory, with a consecutively-numbered file name automatically assigned.

When you are switching SD Memory Cards, you can set your camera to continue consecutive numbering from the previously loaded SD Memory Card.

### Possible Settings

ON (Continue numbering)

File names will be automatically assigned to still images you take, in the format of "R" followed by 7 digits, from R0010001.jpg to R9999999.jpg.

With this setting, even when an SD Memory Card is switched for another, consecutive file numbering from the previous card is continued.

OFF (Do not continue numbering) / Set at purchase

Every time a new card is loaded, file numbering is assigned, from RIMG001.jpg to RIMG999.jpg.

If numbering exceeds RIMG999, further recording is not possible.

- Press the ▼ button to select [SEQUENTIAL NO.].

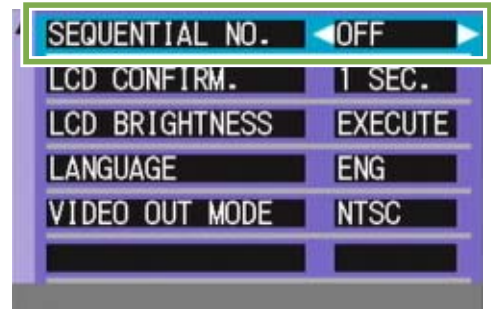

- Press the ◀▶ buttons to select the desired setting.

This setting will be used for shooting until you change it.

To make changes to file numbering, follow the steps below.

- Turn the Mode Dial to SETUP (Setup Mode). The Setup Screen appears.

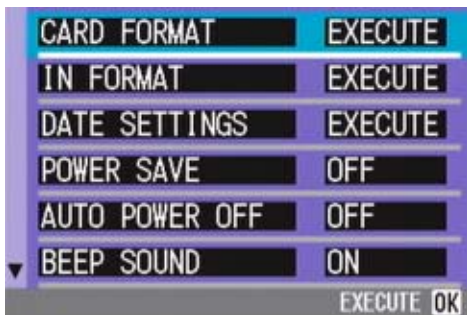

When you are recording to internal memory, file names are assigned just as when [SEQUENTIAL NO.] is set to [OFF].



### Extension

The characters ".jpg" following the period mark in a file name are called the extension and indicate file type. ".jpg" indicates a file is in JPEG format. Extension is always separated from file name by a period.

### JPEG Files

This is read "Jay-Peg" file. This is one of the file formats used for saving image data. It is widely used when recording still images, its strong point being small file size.



## Changing Image Confirmation Time (LCD CONFIRM.)

Immediately after pressing the shutter button, the still image taken is displayed for a moment so you can check it.

At purchase, Confirmation Time is set to one second, but this can be changed.

### Possible Settings

OFF (Photo not displayed for confirmation)  
 1 Minute / Set at purchase  
 2 Seconds  
 3 Seconds

To change Confirmation Time, follow the steps below.

- 1 Turn the Mode Dial to SETUP (Setup Mode).  
The Setup Screen appears.

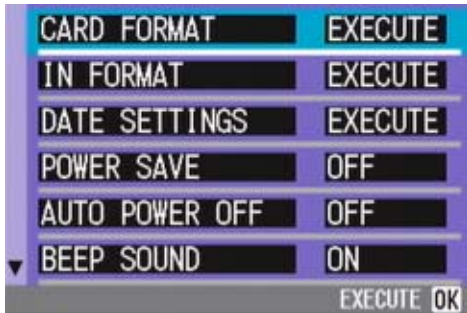

- 2 Press the ▼ button to select [LCD CONFIRM.].

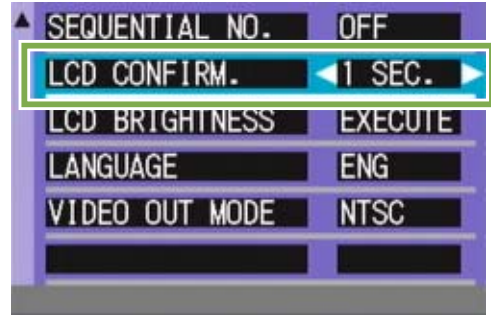

- 3 Press the ◀▶ buttons to select the desired setting.

This setting will be used for shooting until you change it.

## Adjusting the Brightness of the LCD Monitor (LCD BRIGHTNESS)

You can adjust the brightness of the LCD Monitor.

To adjust the brightness of the LCD Monitor, follow the steps below.

- 1 Turn the Mode Dial to **SETUP** (Setup Mode).  
The Setup Screen appears.

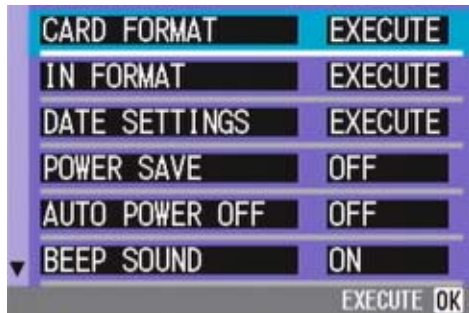

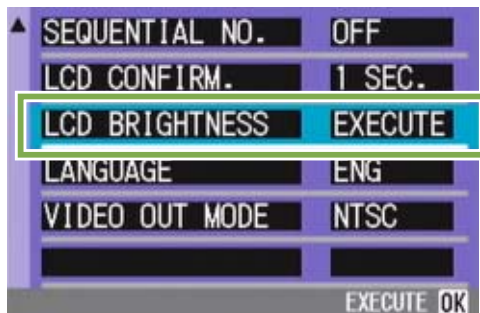

- 2 Press the **▼** button to select [LCD BRIGHTNESS].



- 3 Press the **OK** button.  
The LCD Brightness Adjustment bar appears.



- 4 Press the **▲▼** buttons to adjust the brightness.  
Moving it to the  side makes it darker. Moving it to the  side makes it brighter.  
The brightness of the screen behind the bar changes as you alter the setting.
- 5 When you attain the desired brightness, press the **OK** button.  
The SETUP screen returns.

This setting will be used until you change it.

## Changing the Display Language (LANGUAGE)

You can change the language displayed on the LCD Monitor.

### Possible Settings

JPN (Japanese)  
 ENG (English) / Set at purchase  
 FRE (French)  
 GER (German)  
 CHI (Chinese:simplified characters)

To change the display language, follow the steps below.

- 1 Turn the Mode Dial to SETUP (Setup Mode).  
The Setup Screen appears.

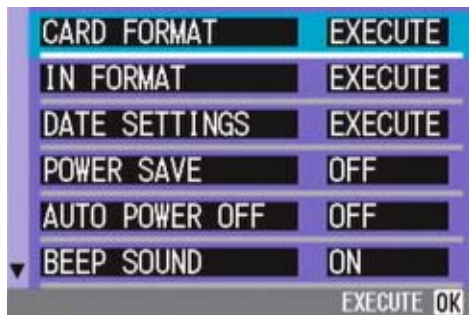

- 2 Press the ▼ button to select [LANGUAGE].

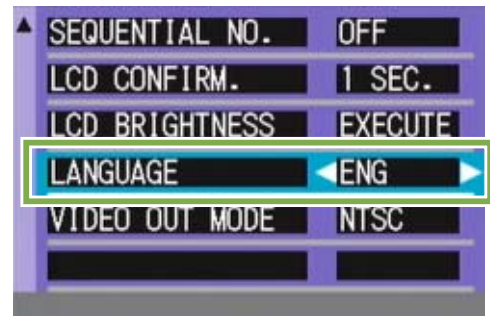

- 3 Press the ◀▶ buttons to select the desired setting.

This setting will be used until you change it.

## Changing the Playback Method for Viewing on TV (VIDEO OUT MODE)

You can view your still images and movies on a television screen by connecting your camera to a television with the video cable (included).

Your camera is set to NTSC video format (used in Japan and other countries) for use with television equipment, etc. If the equipment you want to connect to uses PAL format (used in Europe and elsewhere), then switch your camera to PAL format before connecting.

### Possible Settings

NTSC / Set at purchase  
PAL

To change the playback format, follow the steps below.

- 1 Turn the Mode Dial to SETUP (Setup Mode).  
The Setup Screen appears.

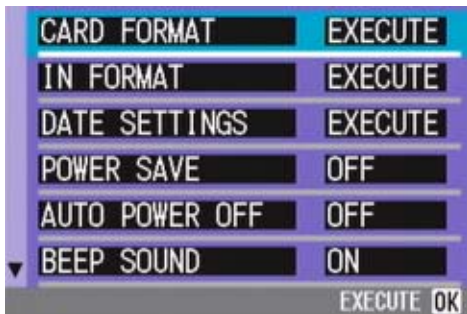

- 2 Press the ▼ button to select [VIDEO OUT MODE].

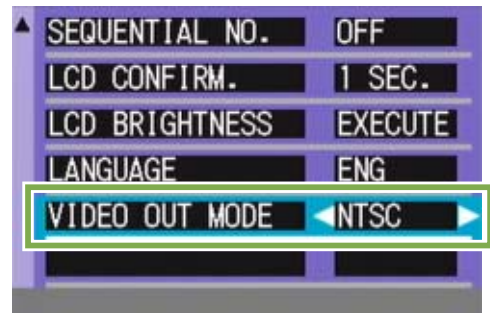

- 3 Press the ◀▶ buttons to select the desired setting.

This setting will be used until you change it.



While the video cable is connected to the camera, the LCD Monitor is tuned off.



For how to view still images on your television screen, see p.80.



# Chapter 2 Enjoying Images on a Computer (Pictures/Movies)

## Section 1 Downloading Images to a Computer

---

This section explains displaying still images and movies you have downloaded to your computer.



**Please do not connect your camera to the computer before installing the software for downloading.**

If you happened to connect your camera to computer (resulting in the [Add New Hardware Wizard] screen appearing), simply click [Cancel], and after disconnecting your camera, install the software on your computer.

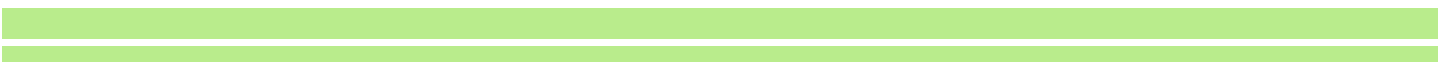

- For the rest of this explanation, still images and movies will be referred to together as "images".
  - When downloading images from your camera, it is recommended you safeguard the power supply by using the AC Adaptor (sold separately). The steps here are explained on the premise that the AC Adaptor is used.
- 

## Using the Software Provided

The CD-ROM that comes with your camera contains software for downloading images from the camera to a computer and displaying them on it. The following software is included.

### For Windows

Application Name	Used For
RICOH Gate L for Windows	Downloading images (Except for Windows XP)
WIA driver	Downloading images (For Windows XP)
USB driver	Connecting your camera to computer
DU-10	Displaying images on your computer

### For Macintosh

Application Name	Used For
Ricoh Gate L for Macintosh	Downloading images
USB driver	Connecting your camera to computer
Mounter	Downloading images

## Software and OS Applicability Table

The software that can be used differs according to the OS in use, as indicated in the table below.

Application Name	Win XP	Win 98/98SE/Me/ 2000	Mac OS 8.6 to 9.2.2	Mac OS X 10.1.2 to 10.1.4
RICOH Gate L	O	X	X	O
DU-10	X	X	O	O
USB driver	O	X	X	X
WIA driver	X	O	O	O
Mounter	O	O	X	X



- If you are using Mac OS X 10.1.2 to 10.1.4, you can display images using Apple's "iPhoto".
- To play movie files in Windows, we use DirectX. If you have an older version that does not allow you to play movie files, install an updated version.

### Installing DirectX

1. Insert the Caplio RR30 Software CD-ROM in the CD-ROM drive and select the [DirectX] folder under the CD-ROM drive using Internet Explorer.
2. If using Windows 98/98SE/Me or Windows 2000, double-click [DX81xxx.exe] and [Win2000] respectively.



## Necessary Environment for Using the Software Provided

The following environments are necessary for using the provided software. Please check your computer, or the computer's user manual.

### Windows

System Requirements	Specification
Compatible computers	Computers with Windows98/98SE/Me/2000/XP pre-installed, with a standard USB Port, whose operation is guaranteed by the PC manufacturer
CPU	Pentium 2 or higher
Memory	Windows 98/98SE: 32 MB or more (96 MB or more recommended)
	Windows Me: 64 MB or more (96 MB or more recommended)
	Windows 2000: 128 MB or more (256 MB or more recommended)
	Windows XP: 128 MB or more (256 MB or more recommended)
Hard drive space required for installation	Windows 98/98SE: 10 MB or more
	Windows Me: 10 MB or more
	Windows 2000: 10 MB or more
	Windows XP: 10 MB or more
Display resolution	640 X 480 dots or greater (800 X 600 or greater recommended)
Display colors	256 colors or greater (65000 or greater recommended)
CD-ROM drive	A CD-ROM drive compatible with the above-mentioned computer body
USB port	A USB port compatible with the above-mentioned computer body



- If your computer has an upgraded OS, the USB function may not work normally, so it cannot be supported.
- Problems may arise due to changes made to the OS, such as through patches or a service package release.
- Connection to a USB port retrofitted using an extended function (PCI bus, etc.) cannot be supported.
- If used in conjunction with a hub or other USB devices, the software may not work properly.
- When dealing with movies and other large files, a larger memory environment is recommended.

## Macintosh

System Requirements	Specification
Operating System	Mac OS 8.6 to 9.2.2/Mac OS X 10.1.2 to 10.1.4
Macintosh	A USB port standard-equipped Apple Macintosh Series
Internal Memory	Mac OS 8.6 to 9.2.2 96 MB or more (128 MB or more recommended) Mac OS X 10.1.2 to 10.1.4 128 MB or more (256 MB or more recommended)
Application allocated Memory (For Mac OS 8.6 to 9.2.2)	Without using the compression utility, 16MB or more (24 MB or more is recommended) as Application Memory
Hard Disc Drive Capacity	Mac OS 8.6 to 9.2.2 10 MB or more (at installation)
	Mac OS X 10.1.2 to 10.1.4 100 MB or more (at installation)
Display Resolution	640 X 480 dots or greater (800 X 600 or greater recommended)
Display Colors	256 colors or greater (32000 or greater recommended)
CD-ROM Drive	A CD-ROM drive compatible with the above-mentioned Macintosh machine
USB Port	A USB Port compatible with the above-mentioned Macintosh machine



- Problems may arise due to changes made to the OS.
- Connection to a USB port retrofitted using an extended function (for example, PCI bus) cannot be supported.
- If used in conjunction with a hub or other USB devices, the software may not work properly.



- When dealing with movies and other large files, a larger memory environment is recommended. For Mac OS 8.6 to 9.2.2, use a larger memory environment, as well as allocating extra application memory.
- While the software can be operated at 256 colors or more for the Display Color, it is strongly recommended that 32,000 or more be used.
- If the computer does not have a USB port, it is possible to download images from SD Memory Card using a PC card slot or card reader.



For how to download images to your computer when using an SD Memory Card, see p.130.

## Installing the Software

Load the software for downloading pictures to your computer (this step is called Install). This section explains the steps of installation for each operating system (OS).

OS in Use	Software to be Installed	Installation Method
Windows 98 98SE Me 2000	RICOH Gate L	p.109
	DU-10	
	USB Driver	
	Operation Manual	
Windows XP	DU-10	p.112
	WIA Driver	
	Operation Manual	
Mac OS 8.6 to 9.2.2	RICOH Gate L	p.114
	Mounter	
	USB Driver	
	Operation Manual	
Mac OS X 10.1.2 to 10.1.4	Mounter	p.116
	USB Driver	
	Operation Manual	

## For Windows 98/98SE/Me/2000

In Windows 2000, only a user with administrative privileges can perform installation.

- 1 Start your computer.
- 2 Insert the CD-ROM in the CD-ROM drive.  
The following screen appears automatically.



- 3 Click [Install Software].  
After a few moments, the [Choose Setup Language] screen appears.



- 4 Select a language to use and then click the [OK] button.  
After a few moments, the [Welcome to the InstallShield Wizard] screen appears.

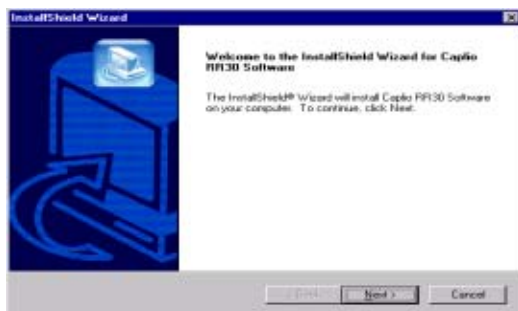

- 5 Click [Next].  
After a few moments, the [Choose Destination Location] screen appears.

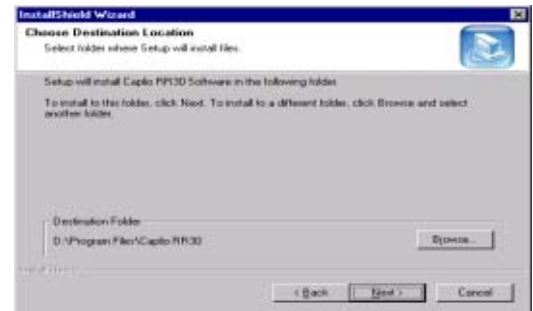

- 6 Confirm where you want to install and then click [Next].  
After a few moments, the [Select Program Folder] screen appears.

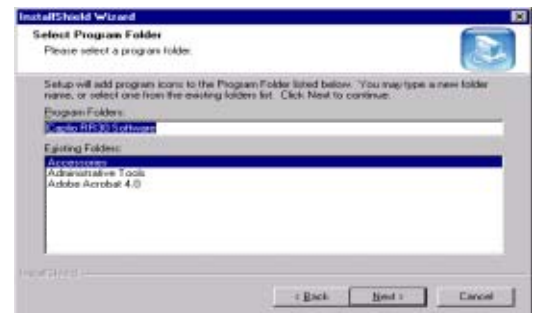

- 7 Confirm the program folder and then click the [Next] button.

Installation begins and after a while the following screen appears.

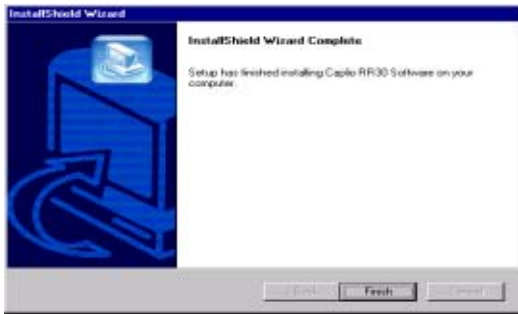

- 8 Click the [Finish] button.  
Installation is complete.



- If it is not displayed automatically, take the following steps.
  1. Double-click the [My Computer] icon, and then double-click the CD-ROM drive icon.
  2. Double-click the AutoRun file (Autorun.exe) displayed in the CD-ROM drive window.
- You may need to restart your computer after installation.

## Uninstalling the Software (For Windows 98/98SE/Me/2000)

After this page, go to p.118

When you want to remove the software, follow the steps below (this operation is called "uninstall").

In Windows 2000, only a user with administrative privileges can perform the uninstall.

- 1 Click [Start] on the Windows task bar.  
The [Start] menu appears.
- 2 Select [Settings] and then [Control Panel].  
The control panel screen appears.
- 3 Double-click the [Add/Remove Programs].  
icon



Add/Remove  
Programs

- 4 Select [Caplio RR30 Software] and then click [Change/Remove].



- 5 Select the language to use and then click the [OK] button.
- 6 A message appears to confirm whether you want to remove the program: click [Yes].
- 7 The uninstall process begins and a message appears when it is finished: click [OK].  
A message may appear prompting you to restart the computer. In this case, select restart then click [Complete]. The computer will restart.
- 8 Once you click [OK], the [Add/Remove Programs] dialog box closes.
- 9 Click the [x] (Close) button to close the control panel.



## For Windows XP

For Windows XP, only a user with administrative privileges can perform installation.

- 1 Start your computer.
- 2 Insert the CD-ROM in the CD-ROM drive.  
The following screen appears automatically on your computer screen.



- 3 Click [Install Software].  
After a few moments, the [Choose Setup Language] screen appears.
- 4 Select the language to use and then click the [OK] button.  
After a few moments, the [Welcome to InstallShield Wizard] screen appears.

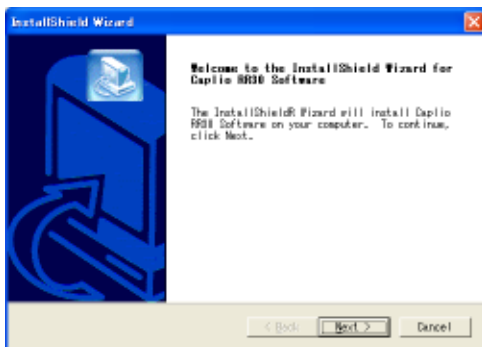

- 5 Click [Next].  
After a few moments, the [Choose Destination Location] screen appears.

- 6 Confirm where you want to install and then click [Next].  
After a few moments, the [Select Components] screen appears.

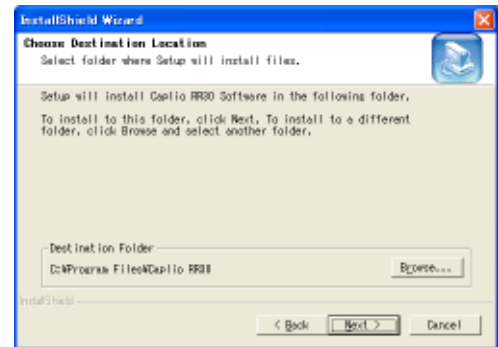

- 7 Confirm the software you want to install and then click [Next].

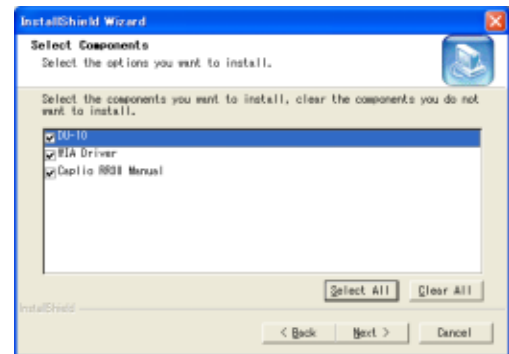

Thereafter, if you continue the operation by following the messages, the [Finish] screen of the [InstallShield Wizard] will appear.

If a message appears asking you whether you want to restart your computer, select [Yes, restart my computer now.] then click [Finish]. The computer will restart.



If it is not displayed automatically, take the following steps.

1. Click the [Start] button on the task bar and then select [My Computer] from the start menu.
2. Double-click the CD-ROM drive icon displayed in the [My Computer] window.
3. Double-click the AutoRun file (Autorun.exe) displayed in the CD-ROM drive window.

## Uninstalling the Software (For Windows XP)

After this page, go to p.118

When you want to remove the software, follow the steps below (this operation is called "uninstall").

For Windows XP, only a user with administrative privileges can perform the uninstall.

- 1 Click [Start] on the Windows task bar.  
The [Start] menu appears.
- 2 Select [Control Panel] from the [Start] menu.  
The control panel screen appears.
- 3 Click the [Add/Remove Programs] icon.
- 4 Select [Caplio RR30 Software] and then click [Change/Remove].
- 5 A message appears to confirm whether you want to remove the program: click [OK].
- 6 The uninstall process begins and a message appears when it is finished. Click [OK].
- 7 Once you click [OK], the [Add/Remove Program] dialog box closes. Click the [×] (Close) button to close the Control Panel.
- 8 After uninstallation, restart your computer.

## For Mac OS 8.6 to 9.2.2

If RCD-iMounter 6.0 was previously installed, remove files in the following manner.

- Delete files that start with RDC that are in the Control Panel folder.
- Delete files that start with RDC that are in the Function Extensions folder.
- Delete files that start with RDC that are in the Initial Settings Folder.

- 7 Click [Install].

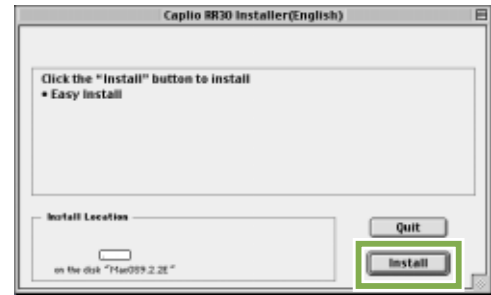

- 8 Click [Continue].

The software is installed and then the Installation Complete message appears.

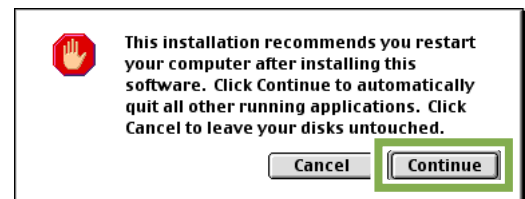

- 9 Click the [Restart] button.

Your Macintosh restarts.

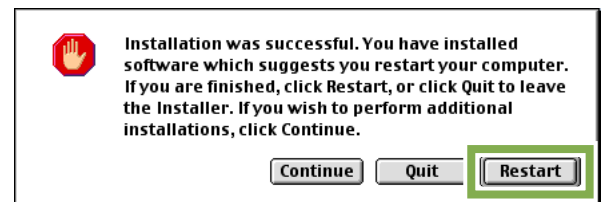

When you start your Macintosh, RICOH Gat L also starts at the same time.

- 1 Turn on your Macintosh.
- 2 Insert the attached CD-ROM in the CD-ROM drive.  
The CD-ROM icon is displayed on the desktop.
- 3 Double-click the CD-ROM icon, and open the [MacOS9] folder.  
The [Caplio RR30 Installer] icon appears.
- 4 Double-click the Installer [Caplio RR30 Installer] icon.



Caplio RR30 Installer

The Installer starts up and the Start screen appears.

- 5 Click [Caplio RR30 Software].



- 6 Click the [OK] button.  
The Installation screen appears.

## Uninstalling the Software (For Mac OS 8.6 to 9.2.2)

After this page, go to p.118

To remove (uninstall) the software from your Macintosh, drag and drop the installed file into the Trash.

Installed file names and destination folders are as follows:

File Name	Folder Name
RICOH Gate L	System Folder: Control Panel
RICOH Gate L Prefs	System Folder: Initial Settings
Caplio Mounter	System Folder: Function Extension
Caplio Mounter Prefs	System Folder: Initial Settings

## For Mac OS X 10.1.2 to 10.1.4

- 1 Turn on your Macintosh.
- 2 Insert the CD-ROM provided into the CD-ROM drive.
- 3 Double-click the CD-ROM icon, and then open the Mac OS X folder.  
The [Caplio Mounter.pkg] icon appears.
- 4 Double-click the Mounter icon [Caplio Mounter.pkg].  
The Installer is launched and a screen appears prompting you for the administrator's password.
- 5 Click the key icon.

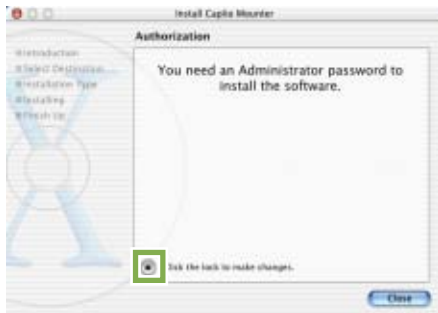

A verification window appears.

- 6 Enter the administrator's name and password, and then click [OK].

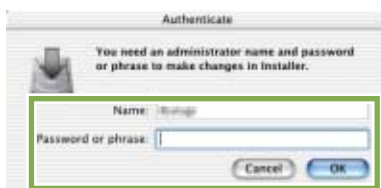

- 7 Click [Continue].



The [Select Installation Destination] screen appears.

- 8 Click the destination volume you want to install and then click [Continue].

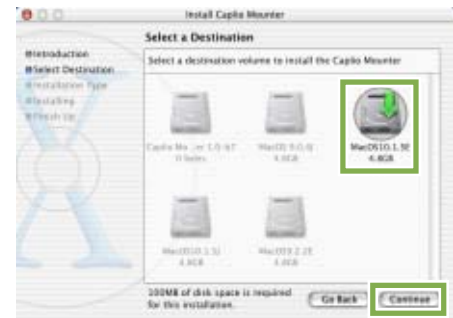

- 9 Click [Install].



After the installation has finishes, a message appears to confirm whether it is necessary to restart your Macintosh or not.

- 10 Click [Continue Installation].

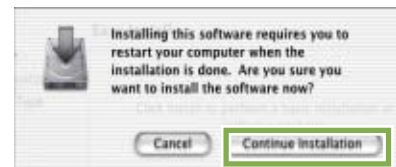

The software is installed, and after a while an Installation Complete message appears.

- 11 Click [Restart].



Your Macintosh restarts.

## Uninstalling the Software (For Mac OS X 10.1.2 to 10.1.4)

After this page, go to p.118

To remove (uninstall) the software from your Macintosh, drag and drop the installed file into the Trash.

The installed file names and destination folders are as follows:

File Name	Folder Name
Caplio Mounter	/Application
Caplio Mounter Prefs	Home Directory Library/Preferences
CaplioStartup	Using the CaplioStartup"Terminal program, enter 'sudo rm -rf /System/Library/Startupitems/CaplioStartup' and delete"

## Connecting the Camera to a Computer

After installing the software on your computer, connect your camera to it.

- 1 Make sure the camera's power is off.
- 2 Connect the USB cable to the USB port of your computer.

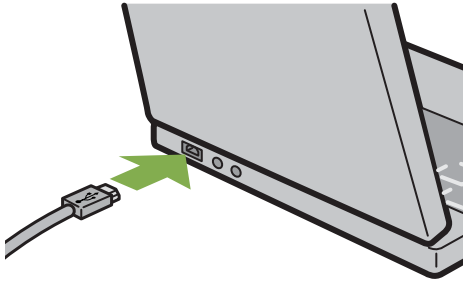

- 3 Open your camera's terminal cover and connect the USB cable to its USB terminal.

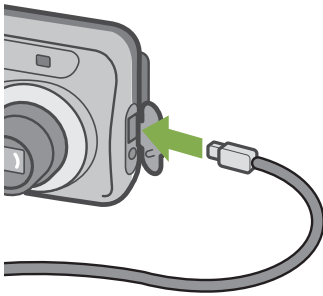

Your camera turns on.

In Windows XP, the first time you connect your camera to the computer using a USB cable, the [New Hardware Detected Wizard] screen will appear.

- 1 Select [Install from a list of specific location (Advanced)].



- 2 Select [Next].

- 3 Select [Search for the best driver in these locations.] -[Include this location in the search] and then press the [Browse] button.

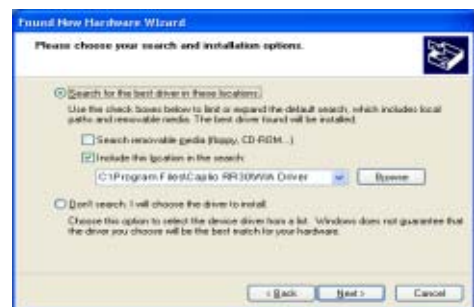

- 4 Select the folder, where the Caplio RR30 Software is installed, that has the [WIA driver] (For example, C:\Program Files\Caplio RR30\WIA driver) and then select [Next].

The WIA Driver is installed.



### Disconnecting your camera from computer

1. Turn your camera off by pressing the power button.
2. Unplug the USB cable.
  - When you are downloading images from your camera, the AC Adaptor (sold separately) is recommended.



## Downloading Pictures to Your Computer

After you have connected your camera to the computer, images automatically download.



Images are downloaded to your computer from the following memory sources.

When no memory card is loaded



Downloads from  
internal memory

When an SD Memory Card is loaded

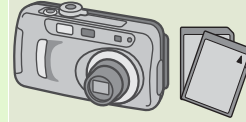

Downloads from SD  
Memory Card



For how to change files names when recording, see p.99.

Downloading methods differ (as described in the following table) depending on the environment used. Follow the steps in the reference pages to download.

For Windows 98/98SE/Me/2000	Downloading using RICOH Gate L.	see p.120
For Windows XP	Downloading using Windows XP functions.	see p.121
For Mac OS 8.6 to 9.2.2	Downloading using RICOH Gate L.	see p.123
For Mac OS X 10.1.2 to 10.1.4	Downloading using Macintosh OSX functions.	see p.124

## For Windows 98/98SE/Me/2000

RICOH Gate L automatically creates a folder called [Caplio] inside your [My Documents] folder. Downloaded images are saved in folders with the date of each shot, inside the [Caplio] folder.

- 1 Connect your camera to the computer using the USB cable.

The camera turns on, RICOH Gate L starts, and the RICOH Gate L window appears.



Image transfer begins automatically.

Once download finishes, DU-10 launches, and you can view the images.



- Before closing RICOH Gate L, if you turn your camera's power off, or unplug the USB cable, the RICOH Gate L window is minimized and displayed as an icon on the Windows task bar. If you click the icon, the window will be displayed again.
- After exiting RICOH Gate L by pressing the [MENU] button and selecting [Close], if you want to restart RICOH Gate L, follow the steps below.  
Select [Program] from the [Start] menu then select Caplio RR30 Software then RICOH Gate L.
- You can change the folder for downloading your images (Save Destination).



- For how to change the Save Destination Folder, see p.126.
- For how to start RICOH Gate L, see p.125.
- For RICOH Gate L screen, see p.125.
- For when images fail to transfer properly, see p.149.

## For Windows XP

- 1 Connect your camera to the computer using the USB cable.

Your camera turns on and the following dialog box appears.

If the screen below appears, select "Microsoft Scanner and Camera Wizard Download pictures from a camera or scanner", check the box next to "Always use this program for this action" and then press [OK].



The scanner and camera wizard starts and the following screen appears.



- 2 Click [Next].

The [Choose Pictures to Copy] screen appears.

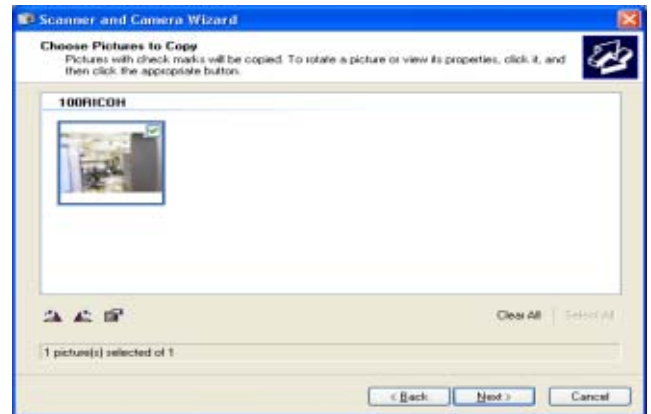

The images in your camera are displayed and marked as checked. Images that are checked will be transferred to your computer.

- 3 Uncheck images you do not want to transfer.

- 4 Click [Next].

The [Picture Name and Destination] screen appears.

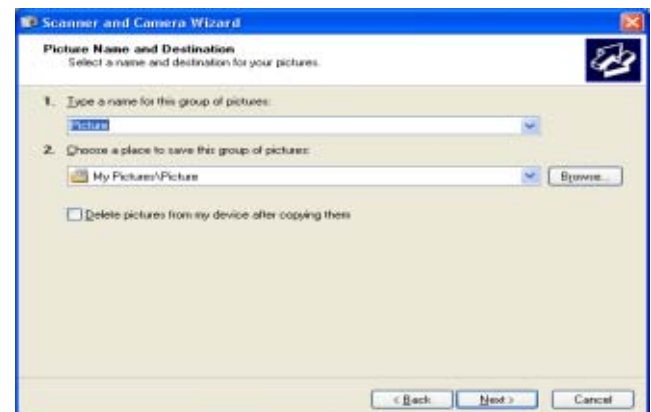

Once you enter a name in [1. Type a name for this group of pictures], the computer saves images with that name followed by a consecutive number.

Enter where you want to save the images in [2. Choose a place to save this group of pictures].

If you check the box in [Delete pictures from my device after copying them], once the images have been transferred to the computer, they will be deleted from your camera's SD Memory Card.

- 5 Make the necessary settings and then click the [Next] button.

The [Copying Images] screen appears and the transfer begins.

Once the transfer is complete, the [Other Options] screen appears.



- 6 You are prompted to confirm [Job Finished] by pressing the [Next] button.

The [Completing the Scanner and Camera Wizard] screen appears.



- 7 Click the [Finish] button.

The Scanner and Camera Wizard is closed and the window of the folder to which the images were transferred is opened, with the images inside displayed. For details of further operations from here onwards, please refer to the Windows XP manual or on-line Help.



- Please refer to the Windows XP manual or on-line help for details on how to use [Publish these pictures to a Web site] or [Order prints of these pictures from a Web site] displayed on the [Other Options] screen.
- After connecting your camera to the computer using the USB cable, if nothing is displayed on your computer screen and downloading fails to start, click [Start] on the Windows task bar, and then select [All Programs] - [Accessories] - [Scanner and Camera Wizard]. Downloading from the camera should then begin.

## For Mac OS 8.6 to 9.2.2

In Mac OS 8.6, Mac OS 9.1, or earlier versions, a folder called [Caplio] is created inside the route directory on the start-up disc [Macintosh HD].

In Mac OS 9.1 to 9.2.2, a folder called [Caplio] is automatically created inside the [Documents] folder on the start-up disc [Macintosh HD].

- 1 Connect your camera to the computer using the USB cable.

The camera turns on, RICOH Gate L starts and the RICOH Gate L window appears.



RICOH Gate L starts and the RICOH Gate L window appears.

Image Transfer begins automatically.

- 2 Click on the [File] menu and select [Quit].



RICOH Gate L closes.

## Using the Mounter

You can transfer images using the Mounter.

- 1 Connect your camera to the computer using the USB cable.

Your camera turns on.

When an SD Memory Card is not loaded, the [Caplio-RR30] icon is displayed and you can view the image files stored in internal memory.



When an SD Memory Card is loaded, the [Caplio-RR30.SD] icon is displayed and you can view the image files stored on the SD Memory Card loaded.



- 2 Double-click the displayed icon.

It can be handled in the same way as a normal drive. If you double-click the icon, a folder called [DCIM] is displayed and a folder called [100RICOH] within that folder is displayed. The image files you shot are inside the [100RICOH] folder.

Drag and drop the file and then copy to the hard disc.



If you want to start RICOH Gate L when the camera is not connected, double-click the [RICOH Gate L] icon in the Control Panel folder, which is inside the System Folder.

The downloaded images are saved in folders with the date of each shot, inside the [Caplio] folder.



For how to change the Save Destination Folder, see p.129.

## For Mac OS X

- 1 Connect your camera to the computer using the USB cable.

Your camera turns on.

When an SD Memory Card is not loaded, the [Caplio-RR30] icon is displayed and you can view the image files stored in internal memory.



When an SD Memory Card is loaded, the [Caplio-RR30.SD] icon is displayed and you can view the image files stored on the SD Memory Card loaded.



- 2 Double-click the displayed icon.

It can be handled in the same way as a normal drive. If you double-click the icon, a folder called [DCIM] is displayed and a folder called [100RICOH] within that folder is displayed. The image files you shot are inside the [100RICOH] folder.

Drag and drop the file and copy to the hard disc.

## How to Use RICOH Gate L

When you are in the RICOH Gate L window, you can specify settings for each of the various functions, such as automatically saving when connected, the destination for downloading images (save destination), and so on.

For details, please read the following pages.

- For Windows 98/98SE/Me/2000, see p.125
- For Mac OS 8.6 to 9.2.2, see p.128

### The RICOH Gate L Window (Windows 98/98SE/Me/2000)

Once RICOH Gate L starts up, the following RICOH Gate L window appears on your computer screen.



#### 1. [MENU Button]

Click this and the following menu appears.

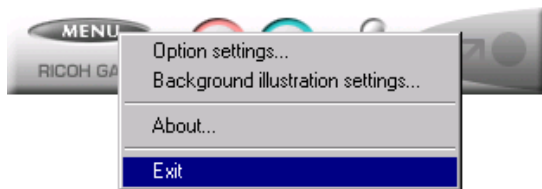

Menu:

[Option settings]: Specifies where to save images, or which application to launch when you press the Application button and after saving. (See p.126)

[Background illustration settings]: Changes the background design in the RICOH Gate L window. (see p.127)

[About]: Displays the version of RICOH Gate L.

[Exit]: Closes RICOH Gate L.

#### 2. [Save Button]

Click this and the images are downloaded from your camera.

#### 3. [Application Button]

The application registered in Optional Settings is launched. DU-10 is registered initially.

#### 4. [Minimize Button]

Minimizes the window and displays its icon on the Windows task bar. If you click on it, the window will be displayed.



#### 5. [Indicator]

The indicator lights if the camera is connected via USB cable. When lit, if you put the mouse pointer on the Indicator, it displays "Camera Connected." When your camera is not connected, the Indicator is grayed out, and if you put the mouse pointer on it, [Camera Connected] does not appear.



## How to Use the Optional settings

If you select [Option settings] from the menu displayed on a button in the RICOH Gate L window, the [Option settings] dialog box appears.

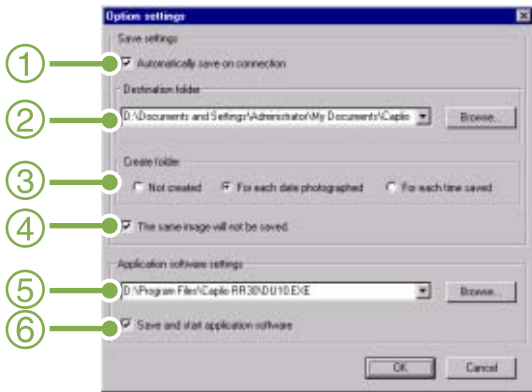

### 1. [Automatically save on connection]

If you check this box, once your camera is connected to the computer, images are automatically downloaded and saved.

If you uncheck the box, even when your camera is connected, your images will not download automatically. Click the [OK] button when you want to download.

**Initial Setting** Execute auto save

### 2. [Destination folder]

Specifies which folder to save your images in. The [Caplio] folder inside [My Documents] is specified initially; if you want to change this, click the [Browse] button to display the dialog box and then specify the folder.

### 3. [Create folder]

Specifies how to create a folder.

[Not created]

Your downloaded images will all be saved in the folder specified in step 2.

[For each date photographed]

Creates a new folder assigning the date it was shot as the folder name, and saves images shot on the same day in the same folder.

The name of the created folder is "date shot."

For example, if shot on May 1, 2002: [20020501] folder

[For each time saved]

Creates a new folder for each time images are saved and saves the images shot at the same time in the same folder. If you save several times in one day, they are saved in separate folders each time.

A folder is created and named according to "The date saved + underline+a 3 digit consecutive number."

For example, if you saved twice on May 1, 2002:

[20020501\_001] folder,

[20020501\_002] folder

**Initial Setting** Each day shot

### 4. [The same image will not be saved.]

You can specify this only when you have selected either [Do not Create] or [Each Day Shot] in [Create a Folder] or if in [Create a Folder] you did not check [Do not save same image when saving].

If you try to save a file to a folder that has an image file of the same name, it will not be saved.

**Initial Setting** Do not save same image

### 5. [Application software settings]

Specify the name of the program if you want an application to launch after you save. The [Caplio] folder DU-10.exe (DU-10 File Name) is specified initially; if you want to change this, click the [Browse] button to display the dialog box and then specify which application to use.

### 6. [Save and start application software]

If this is checked, an application will be launched after saving.

If this is unchecked, no application will be launched.

**Initial Setting** After saving. Launch application

## How to Use the Background Illustration Settings

You can select a background for the RICOH Gate L window from three types of patterns.

If you select [Background illustration setting] from the menu displayed by the [MENU] button in the RICOH Gate L window, the [Background illustration settings] dialog box appears.

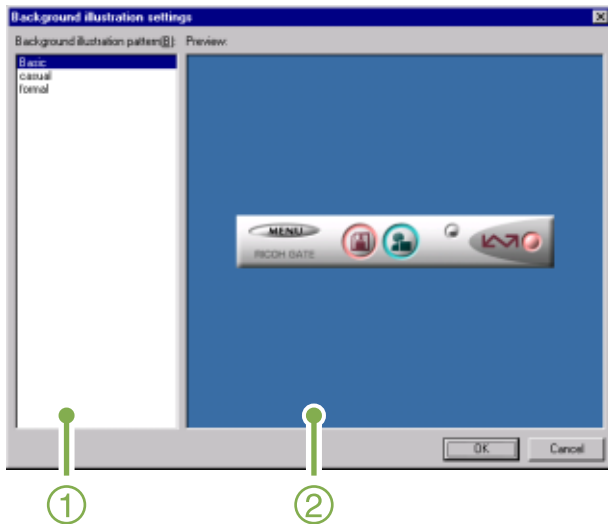

1. [Background illustration pattern]  
Select the pattern you wish to use from the three available.



2. [Preview]  
The pattern selected in [Background illustration pattern] appears, and you can confirm it.

## The RICOH Gate L Window (For Mac OS 8.6 to 9.2.2)

Once RICOH Gate L starts up, the following RICOH Gate L menu bar and window appear on the computer screen.

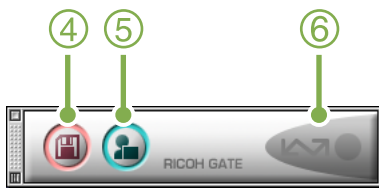
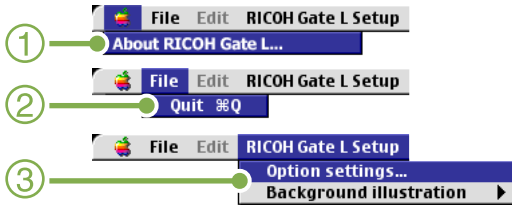

1. [About RICOH Gate]  
Displays the version of RICOH Gate L.
2. [Quit]  
Closes RICOH Gate L.

3. [Option settings]  
Specifies where to save images and which application will launch if you press the Application button or after saving. (See p.129.)

### [Background illustration]

If you select this, a sub-menu will appear, allowing you to change the background design of the RICOH Gate L window.



Sub-menu Figure

4. [Save Button]  
Click this and the images download from your camera.
5. [Application Button]  
The application registered in Optional Settings is launched.
6. [Indicator]  
The indicator lights if the camera is connected via USB cable.

## How to Use Optional Settings

If you select [Optional Settings] from the [RICOH Gate Settings] menu, the [Optional Settings] dialog box appears.

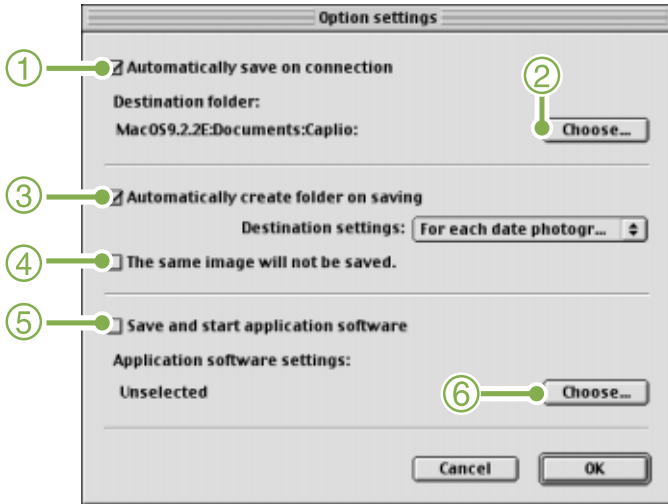

### 1. [Automatically save on connection]

If you check this box, once your camera is connected to computer, the images are automatically downloaded and saved.

If you uncheck the box, even when your camera is connected, your images will not be downloaded automatically. Click the [Save] button when you want to download.

**Initial Setting** Transfer files automatically

### 2. [Choose]

Specifies which folder to save your images in.

For Mac OS 8.6, Mac OS 9.1, or earlier versions, it is in the [Caplio] folder of the Root Directory on the Start-up disc [Macintosh HD].

For Mac OS 9.1 to 9.2.2, it is specified in the [Caplio] folder inside the [Documents] folder on the Start-up disc [Macintosh HD], so if you want to change it, click the [Select] button and in the dialog box that appears, select the folder you wish to specify.

### 3. [Automatically create folder on saving]

Specifies how to create a folder.

[Do not Create]

Your downloaded images will all be saved in the folder specified in step 2.

[For each date photographs]

Creates a new folder assigning the date it was shot as the folder name, and saves images shot on the same day in the same folder.

The name of the created folder is "date shot."

For example, if shot on May 1, 2002:  
[20020501] folder

[Date Transferred + Number Transferred]

Creates a new folder for each time images are saved and saves the images shot at the same time in the same folder.

For example, if saved twice on May 1, 2002:  
[20020501\_001] folder,  
[20020501\_002] folder

**Initial Setting** Each day shot

### 4. [The same image will not be saved.]

You can specify this only when you have selected either [Day Shot] for folder name or if you did not check [Create a folder automatically when transferring] in [Create a Folder].

If you try to save a file to a folder that has an image file of the same name, it will not be saved.

**Initial Setting** Do not save same image

### 5. [Save and start application software]

If this is checked, an application will be launched after saving. If this is unchecked, no application will be launched.

**Initial Setting** Do not start application after transfer

### 6. [Choose]

Specify the name of the application you want to launch after you save. Click the [Choose] button to display the dialog box, and then specify which application to use.

## For Downloading Images Directly to Your Computer from an SD Memory Card

Downloading images via USB connection between computer and camera was explained previously, but it is possible to download images from SD Memory Card to computer via a PC Card Slot or Card Reader.

The FM-SD53 PC Card adaptor (sold separately) is required to load an SD Memory Card into a PC Card Slot or Card Reader.

### Images in a PC Card

Images are stored on SD Memory Card in a hierarchy, as shown here.

```
DCIM
100RICOH
  RIMG0001.jpg
  RIMG0002.jpg
  .
  .
  .
```



- If the card reader is SD Memory Card compatible (or, an SD Memory Card can be loaded as-is), the PC Card Adaptor FM-SD53 (sold separately) is not required.



### Card Reader

This is a device that connects to a computer and can read the contents of cards like the SD Memory Card. In addition to the PC Card type, there are Card Readers compatible with various types of cards, such as SD Memory Cards, into which you can directly insert an SD Memory Card.



## Section 2 Displaying Thumbnail Image (How to Use DU-10)

---

DU-10 enables you to view downloaded images at a glance, as well as editing, rotating and resaving images.

This section explains how to use DU-10.



- DU-10 can only be used in Windows.

## Starting and Exiting DU-10

There are two methods of starting DU-10:

- Auto Start from RICOH Gate L

In the RICOH Gate L option settings, if the Application Software is set to DU-10, and if [After saving, launch Application software] is checked, DU-10 will start automatically after image files have downloaded from your camera with RICOH Gate L.

- Start from Windows [Start] menu

If you select [Program] then [Caplio RR30 Software] then [DU-10] from the [Start] menu, you can start DU-10.

### DU-10 Window

Once you start DU-10, a window like the following appears.

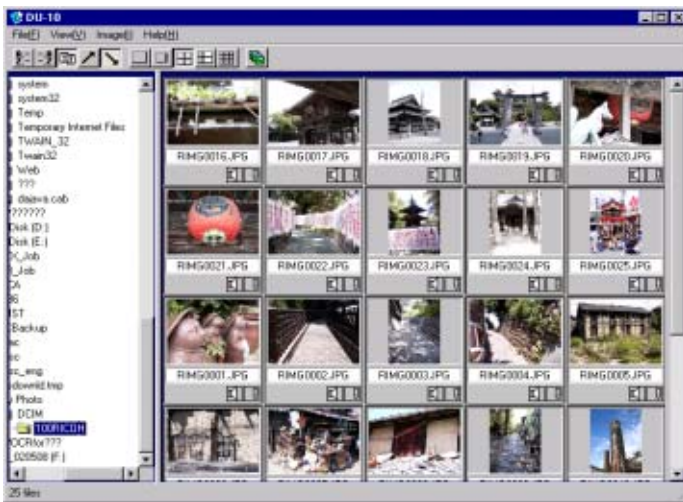

The images you saved are displayed all in one window. This method of displaying reduced size images is called thumbnail display.

### Exiting DU-10

To exit DU-10 and close its window, select [File] from the menu bar, then select [Exit] from the menu displayed, or click the [X] (Close) button in the upper-right corner of the screen.

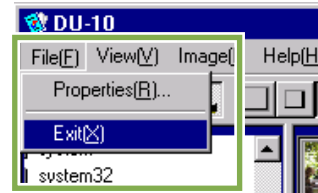

For how to set DU-10 to not launch automatically, see p.126.



## Thumbnail Display Description

Once you start DU-10, images appear as thumbnails.

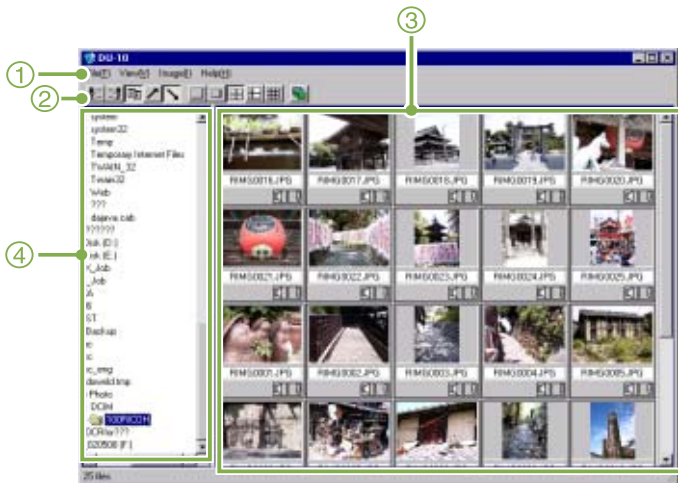

### 1. Menu Bar

You can change the display size and ordering of images.

### 2. Tool Bar

Of the functions available in the menu, the icons of those most frequently used are displayed, so you can use those functions with just one simple click.

### 3. The Thumbnail Display Area

The reduced images are displayed at one glance.

### 4. Folder Display Area

The folders inside [My Computer] are displayed in a hierarchy. The images inside folders selected here appear in the Thumbnail Display Area.

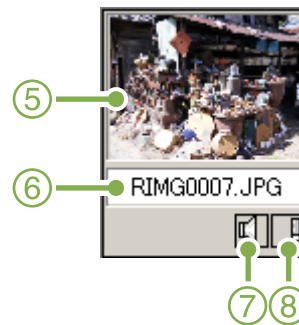

### 5. Thumbnail Image

### 6. File Name

### 7. Sound Setting Y/N Display

### 8. Memo Setting Y/N Display

## Switching the Ordering of Images

Displayed thumbnail images are ordered according to date (descending order).

You can change the ordering method to by file type or by name. You can also choose whether each of the above is ordered according to ascending or descending order.

To change the ordering of images, use either the tool bar or [Arrange] from the [View] menu.

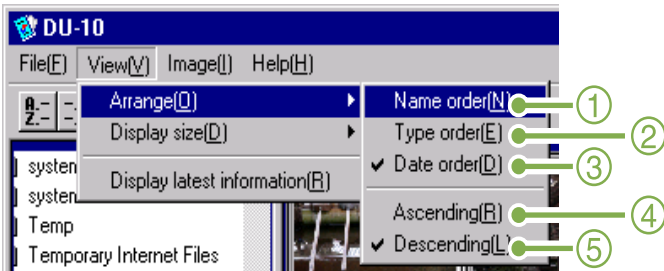

Menu

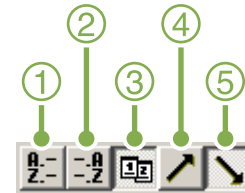

Tool Bar

1. **Name order**  
Switches to By File Name.
2. **Type order**  
Switches to By File Type (in alphabetical order of the extension).
3. **Date order**  
Switches to By Date Shot.
4. **Ascending** / 5. **Descending**  
Ascending order is going from small to large, the opposite is descending order. For the alphabet, a,b,c is ascending order, and z,y,x is descending.  
Select which order to use, 1, 2 or 3 and choose either ascending or descending order.



- If you order by file type, the files are ordered alphabetically according to the file extension.

## Changing the Display Size

To change the display size, use either the tool bar or [Display size] from the [View] menu.

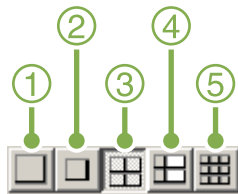
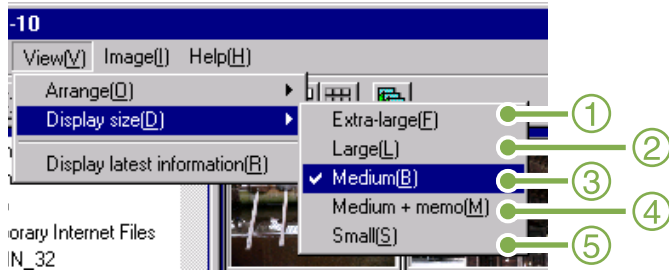

You can change the display size to one of five sizes available.

### 1. Extra-large

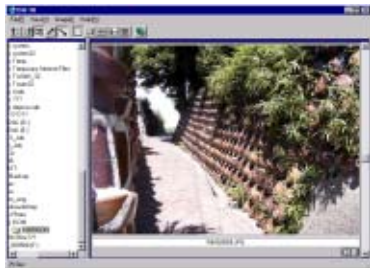

### 2. Large

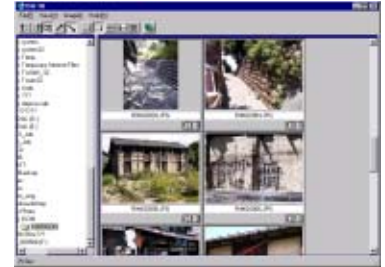

### 3. Medium

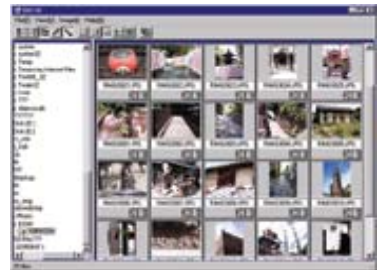

### 4. Medium+ memo

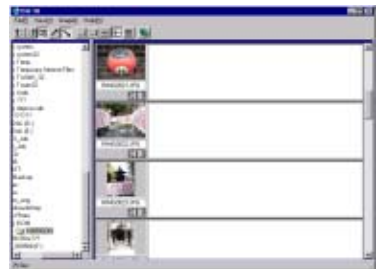

### 5. Small

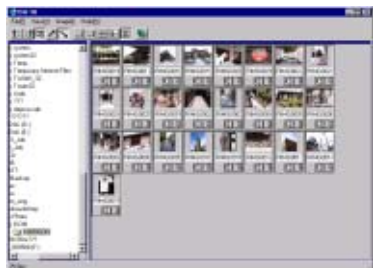

## To View a Slideshow

You can select one or more images and display them as a slideshow.

To start Slideshow, follow the steps below.

### 1 Select the images you wish to see in Slideshow.

If you want to select multiple consecutive images, after clicking the first image, press and hold the [Shift] key and click the last image.

To select multiple images that are not consecutive, press and hold the [Ctrl] while clicking each.

### 2 Using one of the steps below, select [Slideshow].

- Select [Image] then [Slideshow] from the menu bar.
- Place the pointer of the mouse on one of the images you selected, right click and choose [Slideshow] from the menu.

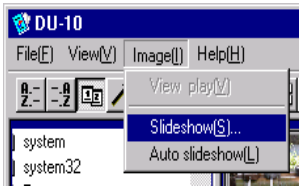

Menu



Shortcut menu displayed with right click

### 3 The [Slideshow] dialog box is displayed, so make the necessary settings.

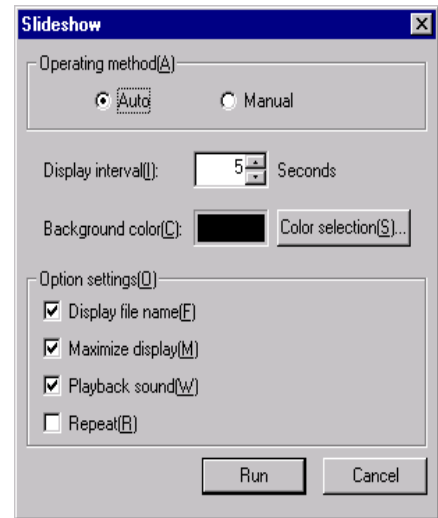

### 4 Click the [Run] button. The Slideshow begins.

#### ■Running a Slideshow

Type of Slideshow	Key	Action
[AUTO] is selected in step 3	[ESC] Key	Stops the Slideshow.
[MANUAL] is selected in step 3	Left-click Mouse	The next image is displayed.
	[Space] Key	
	[Enter] Key	
	[“] Key	
	[Backspace] Key	The previous image is displayed.
	[—] Key	

## Using Auto Slideshow

In Auto Slideshow, all the images displayed as thumbnails appear in order.

To start Auto Slideshow, follow the steps below.

- Using one of the steps below, select [Auto Slideshow].
  - Select [Image] then [Slideshow] from the menu bar.
  - Click the  button on the tool bar.
  - Place the pointer of the mouse on one of the images you selected, right click and choose [Auto-Slideshow] from the menu.

The Slideshow begins.

The images advance automatically according to the display interval (number of seconds) you specified in the [Slideshow] dialog box.

Stop the slideshow with the [Esc] Key.

## How to Use the Slideshow Dialog Box

You can make slideshow display settings in the [Slideshow] dialog box.

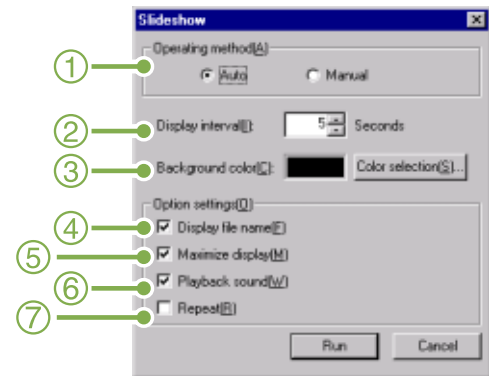

- [Operating method]**  
Select either Auto Slideshow (the slides are played automatically, in order) or Manual (switch frames by clicking the mouse button or pressing the [Enter] key).
- [Display interval]**  
Specify how long in seconds to display each image, when using Auto Slideshow.
- [Background color]**  
Choose a background color for your images. Click the [Choose Color] button and choose a color from the dialog box that appears.
- [Display file name]**  
If you check this box, the file name will appear in the bottom of the image.
- [Maximum display]**  
If you check this box, your images will be displayed at full-screen size.
- [Playback sound]**  
If you check this box, and the images have associated sounds, the sounds will also be played back.
- [Repeat]**  
If you check this box, the sets of images will be shown repeatedly, until you press the [Esc] key to stop. If you uncheck this box, the images in the folder will be displayed through the cycle once, then the slideshow will finish.

## Viewing Image Information

You can display image information, such as the date and time a photo was shot, the size of the image, and so on.



Information Dialog Box

To display image information, follow one of the steps below.

### Using the File Menu

- 1 Click the image in the Thumbnail Display Area for which you want to see information.
- 2 Select [Properties] from the [File] menu.



### Using the Shortcut Menu

- 1 Right-click on the image in the Thumbnail Display Area.  
The menu appears.
- 2 Select [Properties] from the menu.



## Displaying the Viewer Screen

If you use the Viewer screen, images are not displayed as thumbnails, so you can view them at full size. To open the Viewer screen, follow one of the steps below.

- Double click the image you want to display from the thumbnail selection.
- Click the image you want to display from the thumbnail display area, then select [Display/Playback] from the [Image] menu.

### Viewer Screen



Viewer Screen

1. Menu Bar
2. Tool Bar



[Save]

Overwrites an image and saves.



[Rotate 90° counter-clockwise]



[Rotate 90° clockwise]

You can rotate your images 90 degrees to the left or right. You can correct images to their proper vertical/horizontal orientation.



[Enlarged display]



[Actual size view]



[Reduce display]



[Overall view]

You can enlarge or reduce the displayed size.

By repeating [Enlarge Display], you can enlarge the view up to 16 times over original size.

By repeating [Reduce Display], you can reduce the view down to 1/16th of original size.



Saving under a New File Name:

When you want to create a duplicate, or after rotating an image and changing its orientation, if you want to make it into a different file, you can save it and attach a new, different file name.

The only file format you can save in is TIFF.

To save under a new file name, follow the steps below.

- 1 Select [Save as...] from the [File] menu.

The [Save As] dialog box appears.

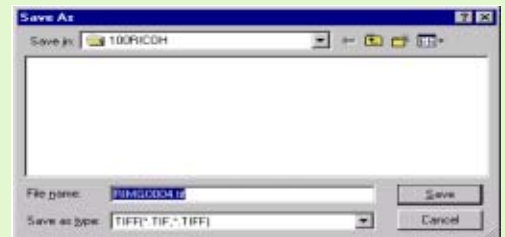

- 2 Specify where to save the new file [Save in].
- 3 Enter the name of the new file in [File Name].
- 4 Click [Save].



### TIFF File

This is read "tiff" file. This is a format used when saving image data as a file. With RR30, images (still images) are saved as files in the small JPEG (jay-peg) file format. TIFF file sizes are larger than JPEG files, but if you want to make frequent changes and resave, TIFF files prevent deterioration.





# **Appendix**



## A. Specifications

### Camera

#### ■ General

Video Signal Format	: NTSC, PAL
Power Source Voltage	: AA Dry Alkaline Batteries (1.5 V) × (2) : Rechargeable Battery (3.7 V) × 1 : External Part (AC Adaptor); 3.8 V
External Dimensions	: 114 mm(W) × 54.5 mm (H) × 32.5 mm (D) (excluding projecting parts)
Weight	: Approx. 160 g (excluding battery/SD Memory Card/Handstrap)
Operating Temperature Range	: 0°C to 40°C
Operating Humidity Range	: 85% or less
Storage Temperature Range	: -20°C to 60°C

#### ■ Camera Parts

Image Pickup Used	: Total 3.34 million pixels (effective pixels 3.24 million)
Lens	: Zoom Lens F2.6 to 4.7
• Focal Length	: F:5.5 to 16.5 mm (35 mm equivalent, 35 to 105 mm)
• Minimum shooting range	: Approx. 1 cm (0.4") (at Wide / Macro Mode)
• Macro Shooting Distance	: 1 to 60 cm
• Digital Zoom	: 3.4 times
Monitor Display Parts	
• Screen Size	: 1.6"
• Type	: Translucent Amorphous Silicon TFT LCD
• Pixel Count	: Approx. 80,000
White Balance	: AUTO/Fixed (Daylight, Overcast, Tungsten light, Fluorescent light, One Push)
Exposure Adjustment	
• Light Metering Sensitive Distribution	: Multi Light Metering (256 segments), Center-weighted Light Metering, Spot Metering
• Exposure Compensation	: Manual Exposure Compensation +/-2.0EV (1/3EV Steps)
• Metering Method	: TTL-CCD Metering Method
• Flash AE	: Yes (In Sun Synchro, Yes)
• Shutter	: Still Images; 8, 4, 2, 1 to 1/2000 second, Movie; 1/30 to 1/2000 sec
• I SO Sensitivity	: Equivalent to ISO 125 (In AUTO), ISO 200, ISO 400, ISO 800
Distance Control	
• AF Method	: Normal Shooting: External Passive / CCD method; Macro: CCD method
• AF Measurement Range	: Normal: approx. 30 cm (11.7") – infinity Macro: approx. 1 – 60 cm (0.4" to 24") (at Wide)
Internal Flash	
• Method	: Auto
• Shooting Distance	: Wide: approx. 0.2 – 4.5 m (1.8 – 7.6 ft.); Tele: approx. 0.15 – 2.5 m (1.8 – 6.1 ft.)
• Operating Modes	: Flash Off/Forced flash/Auto/Slow synchro/Red-eye

### ■Image Data Record/Replay Part

#### Pixels

- Still Images : 2048 × 1536, 1280 × 960, 640 × 480
- Text : 1280 × 960
- Movies : 320 × 240, 160 × 120

#### File Formats

- Still Images : Compressed: JPEG (Exif2.2)
- Text : TIFF (MMR Method ITU-T.6)
- Movies : AVI (Open DML Motion JPEG Format Compliant)

#### Camera File System Standard

: DCF / DCF, is an abbreviation for "Design rule for Camera File system", standardized by JEITA.

#### Compression Format

: JPEG Baseline Format Compliant (Still, Movie)

#### Image Size

- 2048 X 1536 N: approx. 568 KB/Screen, F: approx. 1.12 MB/ Screen
- 1280 X 960 N: approx. 307 KB/Screen, F: approx. 614 KB/ Screen
- 640 X 480 N: approx. 72 KB/ Screen

### ■I/O Terminals

DC In : 3.8 V (AC Adaptor)

Video Out : 1.0 Vp-p (75 Ohms)

■Date Maintain Time : Approx. 2 weeks

### ■Type of Memory Card that can Record,Playback

Memory Type : SD Memory Card, Multi-Media Card

## B. Optional Accessories

The Caplio RR30 can be used with the items (sold separately) listed below.

Item	Model	Remarks
AC Adaptor	AC-4a	For when you want to supply power directly from a wall outlet.
PC Card Adaptor	FM-SD53	For when you want to load an SD Memory Card directly into your computer's PC Card Slot.
Rechargeable Battery	DB-43, DB-40	The RR30 designated rechargeable battery.
Battery Charger	BJ-2	This is a special high-speed (rechargeable) battery charger.

## C. SD Memory Card Recording Capacities

The following table shows the approximate number of images that can be recorded onto an SD Memory Card at various image size and picture quality settings.

Mode	Picture Quality	Image Size	8 MB	32 MB	64 MB
Still Image	F	2048 × 1536	4	19	40
	F	1280 × 960	8	37	75
	N	2048 × 1536	8	37	77
	N	1280 × 960	14	67	138
	N	640 × 480	41	189	387
Text	————	1280 × 960	41	189	387
Movie	————	320 × 240	20 Seconds	90 Seconds	180 Seconds
	————	160 × 120	70 Seconds	320 Seconds	650 Seconds

\* However, the 160 × 120 once max 120 seconds, the 320 × 240, once up to max 30 seconds,

## D. Using Your Camera Abroad

### The AC Adaptor (Model #: AC-4a)

- Can be used in regions with current of 120V, 50Hz / 60Hz.
- If you are going to travel to a country that uses a different shaped wall outlet/plug, please consult your travel agent on a plug adaptor suitable for wall outlets in your country of destination.

### The Warranty

- This product is for domestic use. The attached warranty is only valid domestically.
- In the unlikely event that a failure or breakdown should occur while abroad, please be aware there is no after-sales service or compensation for repairs.

### Using Playback on Television in other Regions

- Playback is possible on televisions (or monitors) equipped with a video input terminal. Please use the video cable provided.
- This camera is compatible with both NTSC and PAL television formats. To use, switch the video format on the camera to match the television environment in the region.
- When you go overseas, set your camera to local video format.

## E. Care and Storage

### ■Care

- Please note that if fingerprints, dirt, etc. get onto the lens, picture quality will suffer.
- When dust or dirt does get on the lens, do not touch it directly with your fingers, and either use a blower (available in stores) to blow it off, or a soft cloth to gently dust it off.
- After use at the beach or around chemicals, wipe it off particularly carefully.
- In the unlikely event that your camera fails to work properly, please consult your Ricoh Repair Center.
- There are high voltage circuits in this camera. As this is dangerous, do not dismantle this camera under any circumstances.
- Do not get volatile substances, such as thinner, benzene, or pesticides on your camera. This may cause a change in quality, paint to peel, etc.
- As the surface of the LCD Monitor is easily scratched, do not rub hard objects against it.
- Please clean the surface of the LCD Monitor with solvents available on the market specially for cleaning LCD display surfaces. Gently wipe with a soft cloth dampened with a little cleaner.

### ■Storage

- Please avoid storing your camera in the following kinds of places, as breakdown may result.
  - In high heat and humidity, or where there is severe change in temperature or humidity
  - Places with a lot of dust, dirt or sand
  - Places with severe vibration
  - In places of direct contact with vinyl products, rubber or chemicals, such as insect repellent, etc.
  - Places with strong magnetic fields (monitors, next to strong magnets, etc.)
- Please remove and store the AA Alkaline batteries (LR6) from this device if you are not going to use it for long periods of time.

### Precautions regarding care of your camera

1. Be sure to turn the power off.
2. Remove the batteries or AC Adaptor before caring for your camera.

## F. Troubleshooting









Refer to the symptoms and measures listed below before submitting the camera for repairs. If the problem persists, contact your nearest Ricoh Service Center.

### ■Power Supply

Symptom	Cause	Measure	Page
The power does not come on.	Batteries are not loaded. Or they are exhausted.	Load the batteries correctly. Recharge or use the AC Adaptor.	p.9 p.10
	The AC Adaptor is not connected correctly.	Reconnect it properly.	p.10
The power cuts out during use.	The camera was left unattended and not used, so Auto Power-Off shut it off.	Turn the power back on.	P.11 p.97
	Batteries are running low.	Recharge the batteries, Replace the batteries with a new set, Or, use the AC Adaptor if necessary.	p.9 p.10
The power does not go off.	Camera malfunction.	Reload batteries. If using the AC Adaptor, reconnect it.	p.9 p.10
Cannot recharge the batteries.	Battery life.	Replace the batteries with a new set.	p.9
Batteries run out quickly.	They are being used in extreme high or low temperatures.	—	—
	Many shots are being taken in dark places inside, requiring flash.	—	—



### ■Shooting

Symptom	Cause	Measure	Page
Even if I press the button, the camera does not shoot.	Batteries are not loaded. Or they are exhausted.	If using alkaline batteries, replace the batteries with a new set. If using rechargeable batteries, recharge or use the AC Adaptor.	p.9
	The power is not on. Or the camera is not in Shooting Mode.	Turn the power on and turn the Mode Dial to Shooting Mode.	p.11
	The shutter button is not pressed all the way.	Press the shutter button all the way.	p.30
	The SD Memory Card is not formatted.	Format the card.	p.94
	The SD Memory Card does not have any free space.	Load a new card, or delete unwanted files.	p.82 p.13
	End of SD Memory Card life.	Load a new SD Memory Card.	p.13
	The flash is recharging.	Wait until the flash lamp stops blinking.	p.44
Even if I press the button, the camera does not shoot.	The SD Memory Card is "locked".	Release the "Lock (write-protection)".	p.13
	The SD Memory Card's contact surfaces are dirty.	Wipe off with a soft, dry cloth.	—
I cannot check shot images.	The image confirmation time is too short.	Lengthen the image confirmation time.	p.100

Symptom	Cause	Measure	Page
Images do not appear on the LCD Monitor.	The power is not on. Or the LCD Monitor is dark.	Turn the power on. Or adjust the brightness of the LCD Monitor.	p.11 p.101
	The video cable is connected.	Disconnect the video cable.	p.80
	The screen display status is in [SYNCHRO-MONITOR MODE].	Press the Display button and switch display.	p.18
	It is set to [POWER SAVE].	Set [POWER SAVE] to off.	p.96
Although it is set to Auto Focus, it does not focus.	The lens is dirty.	Wipe clean with a soft, dry cloth.	—
	The subject is not in the center of the shooting range.	Shoot with Focus Lock.	p.32
	It is a hard-to-focus subject.	Shoot with Focus Lock or Manual Focus.	p.32 p.55
The flash does not fire. Or the flash cannot recharge.	The Shooting Mode is set to  (Multi-Shot) or  (Movie).	Switch the Shooting Mode to  (Still Image).	p.44
	The flash is set to  (Flash Off).	Set to Flash Off with the  button.	p.44
	The White Balance is set to something other than Auto mode.	Set the White Balance to Auto mode.	p.49
	Batteries are running low.	If using alkaline batteries, replace with a new set. If using rechargeable batteries, recharge or use the AC Adaptor.	p.9 p.10
Even though the flash fired, the picture is dark.	The distance to the subject is greater than 2.5 meters in Telephoto or greater than 4.5 meters in Wide-angle.	Get closer to your subject and shoot.	p.44
The image is too bright.	You are too close to the subject.	Set to Flash Off with the  button.	p.44
	It is over-exposed.	Use exposure compensation. Cancel Exposure Time.	p.47 p.63
	The brightness of the LCD Monitor is odd.	Adjust the brightness of the LCD Monitor.	p.101
The image is too dark.	The shot was taken in a dark place while set to  (Flash Off).	Release the Flash Off with the  button.	p.44
	It is under-exposed.	Use exposure compensation. Set to Exposure Time.	p.47 p.63
	The brightness of the LCD Monitor is odd.	Adjust the brightness of the LCD Monitor.	p.101
The image lacks natural color.	The picture was shot in conditions that are hard for Auto White Balance to adjust to.	Add a white object to the composition. Or use Auto Balance in a setting other than Flash shooting or Auto Mode.	p.44 p.49
The date, or recording information does not appear.	The screen display function is set to No Display.	Press the Display button and switch display.	p.18
The brightness of the LCD Monitor changes during AF.	You are using it in a dark place or when Auto Focus range and surrounding brightness are different.	This is normal.	—
There is a vertical smear on the image.	This is a phenomenon that occurs when a bright subject is shot. It is called the smear phenomenon.	This is normal.	—



## ■ Playback/Deleting

Symptom	Cause	Measure	Page
Cannot Playback. Or the Playback screen does not come out.	It is not set to  (Playback).	Turn the Mode Dial to  (Playback Mode).	p.74
	An SD Memory Card is not loaded. Or an SD Memory Card with no stored images is loaded.	Load a card with stored images.	—
	You played back an SD Memory Card that was not formatted by this device.	Load a card that was formatted and stored on by this device.	p.94
	You played back an SD Memory Card that was not recorded normally.	Load a normally recorded card.	p.13
	A file in a format that cannot be played back on this device is stored.	Check the file format.	—
	The VIDEO cable was not connected properly.	Reconnect it properly.	p.80
	The SD Memory Card's contact surfaces are dirty.	Wipe with a soft, dry cloth.	—
Cannot Playback. Or the Playback screen does not come out.	There is something wrong with the SD Memory Card.	Play another card and if there is nothing wrong with it, the camera is OK. There may be something wrong with the card, so do not use it.	—
An image disappeared.	Batteries are running low.	If using alkaline batteries, replace with a new set. If using rechargeable batteries, recharge or use the AC Adaptor.	p.9 p.10
	The camera was left unattended and not used, so Auto Power-Off shut it off.	Turn the power back on.	p.11
Files cannot be deleted.	The file has been set to protect.	Release the protection.	p.85
	The SD Memory Card is "locked".	Release the "Lock (write-protection)".	p.13
Cannot format an SD Memory Card.	The SD Memory Card is "locked".	Release the "Lock (write-protection)".	p.13

## ■ Other Problems

Symptom	Cause	Measure	Page
Cannot load the SD Memory Card.	The card is facing the wrong way.	Load correctly.	p.13
Even when the camera's buttons are pressed, it does not operate.	Batteries are running low.	If using alkaline batteries, replace with a new set. If using rechargeable batteries, recharge or use the AC Adaptor.	p.9 p.10
	Camera Malfunction.	Turn the power off once, turn it back on and switch to  (Still Image).	p.11
		Reset the camera.	p.9 p.10
The date is wrong.	The correct date / time are not set.	Set the correct date / time.	p.12
The date set has disappeared.	The batteries were removed.	If the batteries are removed for about two weeks, the date setting will be lost. Make the settings again.	p.12
Auto Power-Off does not work.	Auto Power-Off is set to OFF.	Set the time for Auto Power-Off.	p.97
The beep does not sound.	The camera is set to silent.	Set the beep to ON.	p.98
Images do not appear on the TV.	The video format is set wrong.	Set to correct format.	p.103
	The cable is not connected.	Reconnect the cable properly.	p.80
	The TV in/out switch is incorrectly set.	Check that the TV in/out switch is set correctly.	—

## ■ About connecting to your computer/software

Symptom	Cause	Measure
Cannot download images	Connect your camera via the USB hub to your computer.	1. Your camera may not be recognized correctly if you connect to the USB Port of your computer via a USB hub. Connect it directly to the USB port of your computer.
Cannot download images (Only for Windows98/98SE/Me)	The COM Port setting is wrong.	1. Connect your camera to the computer with the USB cable. Open [System] from inside the [Control Panel], then open the [Device Manager] in the [System Properties] dialog box. 2. Click the [+] on the left side of [Port COM/LPT] to open, specify [Ricoh Camera Port] and click [Properties]. 3. Click the [Port Select] tab. 4. Select a COM Number not being used from [PortName]. The port currently allocated for your camera is indicated by a "*" . Immediately after installing the USB driver, COM 7 should be selected, so select a number above COM8.
Cannot download images (For all Windows OS's)	The computer is not recognizing the camera correctly.	1. Connect your camera to the computer with the USB cable. Click [Start] on the Windows task bar. 2. Select [Settings], open [System] from inside the [Control Panel], then open the [Device Manager] in the [System Properties] dialog box. / If using the Windows2000/XP, click the [Hardware] tab then click the [Device Manager] button. 3. Click the [+] on the left side of [Other Devices] and make sure there is not a [Digital Camera] below it. If there is, click the [Delete(E:)] button to delete it. Select [Caplio RR30 Software] from [Add/Remove Applications] of the [Control Panel], click the [Add/Remove] button and then install the software. 4. Turn off your camera and computer. 5. Turn your computer back on and reinstall the software from the CD-ROM. (At this time, do not connect the camera.) Next, connect the camera to the computer with the USB cable. When the computer recognizes the camera, the [New Hardware] screen launches and your camera is registered by the computer.
Cannot download images (For Windows98/98SE/Me)	The computer is not recognizing the camera correctly.	1. Connect your camera and computer with the USB cable. Click [Start] on the Windows task bar. 2. Select [Settings], open [System] from inside the [Control Panel], then open the [Device Manager] in the [System Properties] dialog box. 3. Click the [+] on the left side of [Port COM/LPT] to open, and click whether or not there is an Unknown Device symbol (!) indicated for [Ricoh Camera Port]. Alternately, check if there is an Unknown Device symbol (!) indicated for [RICOH USB Virtual COM] under [Universal Serial Controller]. If there is, click the [Delete(E:)] button to delete it. 4. Select [Caplio RR30 Software] from [Add/Remove Programs] of the [Control Panel], click the [Add/Remove] button and then install the software. 5. Turn off your camera and computer. 6. Turn your computer back on and reinstall the software from the CD-ROM. (At this time, do not connect your camera.) Next, connect the camera to the computer with the USB cable. When the computer recognizes the camera, the [New Hardware] screen launches and your camera is registered by the computer.

Symptom	Cause	Measure
Cannot download images (For Windows 2000)	The computer is not recognizing the camera correctly.	<ol style="list-style-type: none"> <li>1. Connect your camera to the computer with the USB cable.</li> <li>2. Click [Start] on the Windows task bar.</li> <li>3. Select Settings, open [System] from inside the [Control Panel], then open the [Device Manager] in the [System Properties] dialog box.</li> <li>4. Click the [+] on the left side of [Port (COM and LPT)] to open, and check if there is an Unknown Device symbol ( ! ) indicated for [Ricoh Camera Port(COMxx)]. If there is, click the [Delete(U:)] button to delete it.</li> <li>5. Select [Caplio RR30 Software] from [Add/Remove Applications] of the [Control Panel], click the [Add/Remove] button and then install the software.</li> <li>6. Turn off your camera and computer.</li> <li>7. Turn your computer back on and reinstall the software from the CD-ROM. (At this time, do not connect your camera.)</li> <li>8. Next, connect the camera to the computer with the USB cable. When the computer recognizes the camera, the [New Hardware] screen launches and your camera is registered by the computer.</li> </ol>
Cannot download images (For Windows XP)	The computer is not recognizing the camera correctly.	<ol style="list-style-type: none"> <li>1. Connect your camera to the computer with the USB cable.</li> <li>2. Click [Start] on the Windows task bar.</li> <li>3. In Windows XP, if you open the [Control Panel] and click on [Switch to Classic Display] in the control panel, the [System] icon is displayed.</li> <li>4. Click the [System] icon, select the [Hardware] tab and click [Device Manager].</li> <li>5. Click the [+] on the left side of [Imaging Device] to open, then check if there is an Unknown Device symbol ( ! ) indicated for [Caplio RR30]. If there is, click the [Delete(U:)] button to delete it.</li> <li>6. Select [Caplio RR30 Software] from [Add/Remove Programs] of the [Control Panel], click the [Add/Remove] button and then install the software.</li> <li>7. Turn off your camera and computer.</li> <li>8. Turn your computer back on and reinstall the software from the CD-ROM. (At this time, do not connect your camera.)</li> <li>9. Next, connect the camera to the computer with the USB cable. When the computer recognizes the camera, the [New Hardware] screen launches and your camera is registered by the computer.</li> </ol>
Even if you check [Do not save same images when saving], in the Ricoh Gate L Optional Settings, the same images end up being downloaded to your computer.	The camera's clock is incorrectly set, or the camera's clock information has been reset.	In order for the [Do not save same images when saving] function to work properly, the camera's clock needs to be set correctly. Set the camera's clock information correctly. For how to set the camera's clock information, see p.12.
Files downloaded from the camera were deleted by the computer. You tried to download the same files from your camera again, but they could not be downloaded.	In the Ricoh Gate L Optional Settings, if you insert a check in [Do not save same images when saving], files already downloaded to your computer cannot be download again.	In the Ricoh Gate L Optional Settings, uncheck [Do not save same images when saving].

## G. Error Messages

If an error message is displayed on the LCD Monitor, follow the procedures below.

Error Message	Countermeasure	Page
INSERT CARD	A card is not loaded. Insert a card.	(see p.13)
SET DATE	The date is not set. Set the date.	(see p.12)
FILE NUMBER OVER LIMIT	The file number limit has been exceeded. Please use another card, or delete unwanted files.	(see p.13, 82)
UNMATCHED FILE	A file that cannot be played back was selected.	—
INSUFFICIENT MEMORY. CONTINUE?	Because there is not sufficient capacity on the card, all the files cannot be copied. Use another card.	(see p.89)
PROTECTED	You are trying to delete a protected file.	(see p.85)
WRITE-PROTECTED	The card is "Locked (write-protection)". Unlock the card.	(see p.13)
PRINT SETTINGS CANNOT BE SET FOR THIS FILE.	This file (movies and other) cannot be selected for printing.	—
INSUFFICIENT MEMORY	Files cannot be stored. Make sure there is enough free space, or delete files.	(see p.82)
	The image print number limit has been exceeded. Select an image and set the number to 0.	(see p.90)
FORMAT INTERNAL MEMORY	It is necessary to format internal memory.	(see p.95)
FORMAT CARD	The card is not formatted. Format the card.	(see p.94)
CARD ERROR	Please reformat. If, after doing so, the error message still appears, the card may be faulty. Do not use the card.	—
WRITE TO CARD	Writing file to memory. Wait until writing finishes.	—
NO FILE	There are no files that can be played back.	—
CANNOT RECORD	The Number of remaining shots is 0. Switch to another card or internal memory.	—



If the countermeasures above do not remedy the problem, please contact the Ricoh Service Center, or the store where you purchased your camera.

## H. About the Warranty and Servicing

1. This product is backed by a limited warranty. During the warranty period mentioned in the Warranty supplied with your camera, any defective parts will be repaired free of charge. In the event of a camera malfunction, contact the dealer from which you purchased the camera or your nearest Ricoh service office. Please note that you will be not be reimbursed for the cost of bringing the camera to the Ricoh service office.
2. This warranty does not cover any damage resulting from:
  1. failure to follow the instructions in the instruction manual;
  2. repair, modification or overhaul not conducted by an authorized service center listed in the instruction manual;
  3. fire or natural disaster;
  4. improper storage, such as exposing the camera to high temperatures, humidity, or mothballs; storing it with a leaking battery; storing the camera in a dirty condition so that it becomes moldy; or otherwise insufficiently caring for the camera;
  5. Submergence; exposure to floods or spilled alcohol or other beverages; allowing sand or mud to enter the camera; exposure to physical shocks; or dropping the camera.
3. After the warranty period has passed, you will be liable for all repair fees, including those incurred at an authorized service center.
4. You will be liable for all repair fees, even within the warranty period, if the warranty card is not attached or if the distributor's name or the purchase date have been changed or are not indicated on the card.
5. Expenses for overhaul and thorough inspection by special request of the customer will be charged to the customer, whether or not they are incurred during the warranty period.
6. This warranty only applies to the camera and not to the accessories, such as the case and strap, nor does it apply to the battery and other consumables provided.
7. Any consequential damages arising from failure of the camera, such as expenses incurred in taking pictures or loss of expected profit, will not be reimbursed whether they occur during the warranty period or not.
8. The above provisions refer to repairs offered free of charge, and do not limit your legal rights. The intention of the above provisions is also described in the warranty card provided with this camera.
9. Parts essential to the servicing of the camera (that is, components required to maintain the functions and quality of the camera) will be available for a period of seven years after the camera is discontinued. However, as some parts are kept for a longer period, do not hesitate to contact your distributor or nearest Ricoh service office even after the seven-year period.
10. Please note that if the camera is seriously damaged by flooding, submergence, infiltration of sand or mud, violent shocks or dropping, it may not be repairable, and restoration to its original condition may be impossible.



- Before sending the camera in for repair, check the battery and read the instruction manual again to ensure proper operation.
- Some repairs require a significant amount of time to be completed.
- When sending the camera to a service center, please include a note which describes the defective part and the problem as precisely as possible.
- Remove all accessories not related to the problem before sending the camera to the service center.
- Before taking any important pictures (such as at weddings, on trips abroad, etc.), test the camera to check operation and ensure proper functioning. We recommend that you keep this manual and spare battery on hand.
- This warranty does not apply to data stored on an SD Memory Card or in internal memory.



Declaration of Conformity

“The Product complies with the requirements of the EMC Directive 89/336/EEC.”



## INFORMATION TO THE USER

### USA FCC Part15 Class B

The equipment has been tested and found to comply with the limits for a Class B digital device, pursuant to part 15 of the FCC Rules. These limits are designed to provide reasonable protection against harmful interference in a residential installation. This equipment generates, user, and can radiate radio frequency energy and if not installed and used in accordance with the instructions, may cause harmful interference to radio communications. However, there is no guarantee that interference will not occur in a particular installation. In this equipment does cause harmful interference to radio or television reception, which can be determined by turning the equipment off and on, the user is encouraged to try to correct the interference by one or more of the following measures:

- Reorient or relocate the receiving antenna.
- Increase the separation between the equipment and receiver.
- Connect the equipment to outlet on a circuit different from that to which the receiver is connected.
- Consult the dealer or an experienced radio/TV technician for help. (FCC 15.105B)

Changes or modifications not expressly approved by the party responsible for compliance could void the user's authority to operate the equipment. (FCC 15.21)

Properly shielded and grounded cables and connectors must be used for connection to a host computer in order to comply with FCC emission limits. (FCC 15.27)

An AC adapter with a ferrite core must be used for RF interference suppression.

## COMPLIANCE INFORMATION STATEMENT

Product Name: DIGITAL CAMERA

Model Number: Caplio RR30

This device complies with Part 15 of the FCC Rules.

Operation is subject to the following two conditions:

- (1) This device may not cause harmful interference, and
- (2) This device must accept any interference received, including interference that may cause undesired operation.

RICOH CORPORATION

5 Dedrick Place, West Caldwell NJ, 07006ppTel.: 1-800-225-1899

### Note to Users in Canada

**Note:** This Class B digital apparatus complies with Canadian ICES-003

### Remarque Concernant les Utilisateurs au Canada

Avertissement: Cet appareil numerique de la classe B est conforme a la norme NMB-003 du Canada

IMPORTANT SAFETY INSTRUCTIONS-SAVE THESE INSTRUCTIONS DANGER-TO REDUCE THE RISK OF FIRE OR ELECTRIC SHOCK, CAREFULLY FOLLOW THESE INSTRUCTIONS.

## Telephone Support Numbers in Europe

UK	(from within the UK) (from outside of the UK)	02073 656 580 +44 2073 656 580
Deutschland	(innerhalb Deutschlands) (außerhalb Deutschlands)	06331 268 438 +49 6331 268 438
France	(à partir de la France) (en dehors de la France)	0800 91 4897 +33 800 91 4897
Italia	(dall'Italia) (dall'estro)	02 696 33 451 +39 02 696 33 451
España	(desde España) (desde fuera de España)	91 406 9148 +34 91 406 9148

## Ricoh Service Offices

Ricoh Company, Ltd.  
3-2-3, Shin-yokohama  
Kohoku-ku, Yokohama-shi 222-8530  
Japan  
[http://www.ricoh.co.jp/r\\_dc](http://www.ricoh.co.jp/r_dc)

Ricoh Factory Service Center  
250 North 54th Street  
Chandler, AZ 85226  
<http://www.ricohzone.com/>

RICOH EUROPE B.V. (PMMC EUROPE)  
Oberrather Straße 6  
D-40472 Düsseldorf  
Germany  
<http://www.ricohpmmc.com>

RICOH UK LTD. (PMMC UK)  
Ricoh House  
1 Plane Tree Crescent  
Feltham, Middlesex TW13 7HG  
England

RICOH FRANCE S.A. (PMMC FRANCE)  
383, Avenue du Général de Gaulle –  
BP 307-931-13 Clamart Cédex,  
France

RICOH ESPANA, S.A. (PMMC SPAIN)  
Av. Litoral Mar, 12-14,  
08005 Barcelona,  
Spain

RICOH EUROPE B.V. (PMMC BENELUX)  
Koolhovenlaan 35,  
1119 NB Schiphol-Rijk,  
The Netherlands

RICOH HONG KONG LIMITED  
Personal Multimedia Products Center  
21/F., Tai Yau Building, 181 Johnston Road,  
Wan Chai, Hong Kong

Ricoh Australia Pty. Ltd.  
8 Rodborough Road  
Frenchs Forrest, N.S.W. 2086  
Australia  
<http://www.ricoh.com.au>